

# HP 17bII+ Financial Calculator

---

## Owner's Manual



i n v e n t

Edition 1

Part Number F2234-90020

---

## Notice

For warranty and regulatory information for this calculator, see the owner's manual.

This manual and any examples contained herein are provided "**as is**" and are subject to change without notice. *Hewlett-Packard Company makes no warranty of any kind with regard to this manual, including, but not limited to, the implied warranties of merchantability and fitness for a particular purpose.* Hewlett-Packard Co. shall not be liable for any errors or for incidental or consequential damages in connection with the furnishing, performance, or use of this manual or the examples contained herein.

© Copyright 2003 Hewlett-Packard Development Company, L.P.  
Reproduction, adaptation, or translation of this manual is prohibited without prior written permission of Hewlett-Packard Company, except as allowed under the copyright laws.

The programs that control your calculator are copyrighted and all rights are reserved. Reproduction, adaptation, or translation of those programs without prior written permission of Hewlett-Packard Co. is also prohibited.

4995, Murphy Canyon Rd,  
Suite 301  
San Diego, CA 92123

---

## Printing History

**Edition 1**

**June 2003**

# Welcome to the HP 17bII+

---

The HP 17bII+ is part of Hewlett-Packard's new generation of calculators:

- The *two-line display* has space for messages, prompts, and labels.
- Menus and messages show you options and guide you through problems.
- *Built-in applications* solve these business and financial tasks:
  - **Time Value of Money.** For loans, savings, leasing, and amortization.
  - **Interest Conversions.** Between nominal and effective rates.
  - **Cash Flows.** Discounted cash flows for calculating net present value and internal rate of return.
  - **Bonds.** Price or yield on any date. Annual or semi-annual coupons; 30/360 or actual/actual calendar.
  - **Depreciation.** Using methods of straight line, declining balance, sum-of-the-years' digits, and accelerated cost recovery system.
  - **Business Percentages.** Percent change, percent total, markup.
  - **Currency Exchange.** Exchange calculations between two currencies.
  - **Statistics.** Mean, correlation coefficient, linear estimates, and other statistical calculations.
  - **Clock.** Time, date, and appointments.
- Use the *Solver* for problems that aren't built in: type an equation and then solve for any unknown value. It's easier than programming!
- There are 28K bytes of memory to store data, lists, and equations.
- You can print information using the HP 82240 Infrared Printer.
- You can choose either ALG (Algebraic) or RPN (Reverse Polish Notation) entry logic for your calculations.

# Contents


---

<b>13</b>	<b>List of Examples</b>
<b>16</b>	<b>Important Information</b>


---

<b>1</b>	<b>17</b>	<b>Getting Started</b>
	<b>17</b>	Power On and Off; Continuous Memory
	<b>17</b>	Adjusting the Display Contrast
	<b>18</b>	Setting the Language
	<b>18</b>	What You See in the Display
	<b>19</b>	The Shift Key (⇧)
	<b>19</b>	Backspacing and Clearing
	<b>21</b>	Doing Arithmetic
	<b>22</b>	Keying in Negative Numbers (±/−)
	<b>22</b>	Using the Menu Keys
	<b>23</b>	The MAIN Menu
	<b>25</b>	Choosing Menus and Reading Menu Maps
	<b>27</b>	Calculations Using Menus
	<b>28</b>	Exiting Menus (EXIT)
	<b>28</b>	Clearing Values in Menus
	<b>29</b>	Solving Your Own Equations (SOLVE)
	<b>30</b>	Typing Words and Characters: the ALPHAbetic Menu
	<b>31</b>	Editing ALPHAbetic Text
	<b>32</b>	Calculating the Answer (CALC)
	<b>34</b>	Controlling the Display Format
	<b>34</b>	Decimal Places
	<b>34</b>	Internal Precision
	<b>34</b>	Temporarily SHOWing ALL
	<b>35</b>	Rounding a Number
	<b>35</b>	Exchanging Periods and Commas in Numbers

## 4 Contents

- 36 Error Messages
- 36 Modes
- 37 Calculator Memory (  MEM )

---

<b>2</b>	<b>38</b>	<b>Arithmetic</b>
	38	The Calculator Line
	38	Doing Calculations
	40	Using Parentheses in Calculations
	40	The Percent Key
	40	The Mathematical Functions
	41	The Power Function (Exponentiation)
	42	The MATH Menu
	43	Saving and Reusing Numbers
	43	The History Stack of Numbers
	44	Reusing the Last Result (  LAST )
	45	Storing and Recalling Numbers
	46	Doing Arithmetic Inside Registers and Variables
	47	Scientific Notation
	48	Range of Numbers

---

<b>3</b>	<b>49</b>	<b>Percentage Calculations in Business</b>
	50	Using the BUS Menus
	50	Examples Using the BUS Menus
	50	Percent Change (%CHG)
	51	Percent of Total (%TOTL)
	52	Markup as a Percent of Cost (MU%C)
	52	Markup as a Percent of Price (MU%P)
	53	Sharing Variables Between Menus

---

<b>4</b>	<b>54</b>	<b>Currency Exchange Calculation</b>
	54	The CURRX Menu
	55	Selecting a Set of Currencies
	57	Entering a Rate

<b>59</b>	Converting between Two Currencies
<b>59</b>	Storing and Recalling Sets of Currencies
<b>60</b>	Clearing the Currency Variables

---

<b>5</b>	<b>61</b>	<b>Time Value of Money</b>
	<b>61</b>	The TVM Menu
	<b>64</b>	Cash Flow Diagrams and Signs of Numbers
	<b>66</b>	Using the TVM Menu
	<b>67</b>	Loan Calculations
	<b>71</b>	Savings Calculations
	<b>74</b>	Leasing Calculations
	<b>77</b>	Amortization (AMRT)
	<b>78</b>	Displaying an Amortization Schedule
	<b>81</b>	Printing an Amortization Table

---

<b>6</b>	<b>84</b>	<b>Interest Rate Conversions</b>
	<b>85</b>	The ICNV Menu
	<b>85</b>	Converting Interest Rates
	<b>87</b>	Compounding Periods Different from Payment Periods

---

<b>7</b>	<b>91</b>	<b>Cash Flow Calculations</b>
	<b>91</b>	The CFLO Menu
	<b>92</b>	Cash Flow Diagrams and Signs of Numbers
	<b>94</b>	Creating a Cash-Flow List
	<b>95</b>	Entering Cash Flows
	<b>97</b>	Viewing and Correcting the List
	<b>98</b>	Copying a Number from a List to the Calculator Line
	<b>98</b>	Naming and Renaming a Cash-Flow List
	<b>99</b>	Starting or GETting Another List
	<b>99</b>	Clearing a Cash-Flow List and Its Name
	<b>100</b>	Cash-Flow Calculations: IRR, NPV, NUS, NFV
	<b>107</b>	Doing Other Calculations with CFLO Data

## **6**   **Contents**

---

<b>8</b>	<b>108</b>	<b>Bonds</b>
	<b>108</b>	The BOND Menu
	<b>110</b>	Doing Bond Calculations

---

<b>9</b>	<b>114</b>	<b>Depreciation</b>
	<b>114</b>	The DEPRC Menu
	<b>116</b>	Doing Depreciation Calculations
	<b>116</b>	DB, SOYD, and SL Methods
	<b>118</b>	The ACRS Method
	<b>119</b>	Partial-Year Depreciation

---

<b>10</b>	<b>121</b>	<b>Running Total and Statistics</b>
	<b>122</b>	The SUM Menu
	<b>123</b>	Creating a SUM List
	<b>123</b>	Entering Numbers and Viewing the TOTAL
	<b>124</b>	Viewing and Correcting the List
	<b>126</b>	Copying a Number from a List to the Calculator Line
	<b>126</b>	Naming and Renaming a SUM List
	<b>127</b>	Starting or GETting Another List
	<b>127</b>	Clearing a SUM List and Its Name
	<b>127</b>	Doing Statistical Calculations (CALC)
	<b>128</b>	Calculations with One Variable
	<b>130</b>	Calculations with Two Variables (FRCST)
	<b>133</b>	Curve Fitting and Forecasting
	<b>138</b>	Weighted Mean and Grouped Standard Deviation
	<b>139</b>	Summation Statistics
	<b>140</b>	Doing Other Calculations with SUM Data

---

<b>11</b>	<b>141</b>	<b>Time, Appointments, and Date Arithmetic</b>
	<b>141</b>	Viewing the Time and Date

<b>142</b>	The Time Menu
<b>143</b>	Setting the Time and Date (SET)
<b>144</b>	Changing the Time and Date Formats (SET)
<b>144</b>	Adjusting the Clock Setting (ADJUST)
<b>145</b>	Appointments (APPT)
<b>145</b>	Viewing or Setting an Appointment (APT1-APT10)
<b>147</b>	Acknowledging an Appointment
<b>148</b>	Unacknowledged Appointments
<b>148</b>	Clearing Appointments
<b>149</b>	Date Arithmetic (CALC)
<b>150</b>	Determining the Day of the Week for Any Date
<b>150</b>	Calculating the Number of Days between Dates
<b>151</b>	Calculating Past or Future Dates

---

<b>12</b>	<b>153</b>	<b>The Equation Solver</b>
	<b>153</b>	Solver Example : Sales Forecasts
	<b>156</b>	The SOLVE Menu
	<b>157</b>	Entering Equations
	<b>158</b>	Calculating Using Solver Menus (CALC)
	<b>161</b>	Editing an Equation (EDIT)
	<b>161</b>	Naming an Equation
	<b>162</b>	Finding an Equation in the Solver List
	<b>162</b>	Shared Variables
	<b>162</b>	Clearing Variables
	<b>163</b>	Deleting Variables and Equations
	<b>164</b>	Deleting One Equation or Its Variables (DELET)
	<b>164</b>	Deleting All Equations or All Variables in the Solver <input type="checkbox"/> (CLR DATA)
	<b>164</b>	Writing Equations
	<b>166</b>	What Can Appear in an Equation
	<b>168</b>	Solver Functions
	<b>174</b>	Conditional Expressions with IF
	<b>176</b>	The Summation Function ( $\Sigma$ )
	<b>177</b>	Accessing CFLO and SUM Lists from the Solver
	<b>178</b>	Creating Menus for Multiple Equations (S Function)



<b>179</b>	How the Solver Works
<b>180</b>	Halting and Restarting the Numerical Search
<b>181</b>	Entering Guesses

---

<b>13</b>	<b>184</b>	<b>Printing</b>
	<b>185</b>	The Printer's Power Source
	<b>185</b>	Double-Space Printing
	<b>185</b>	Printing the Display( <b>PRT</b> )
	<b>186</b>	Printing Other Information ( <b>PRINTER</b> )
	<b>186</b>	Printing Variables, Lists, and Appointments (LIST)
	<b>188</b>	Printing Descriptive Messages (MSG)
	<b>188</b>	Trace Printing (TRACE)
	<b>189</b>	How to Interrupt the Printer

---

<b>14</b>	<b>190</b>	<b>Additional Examples</b>
	<b>190</b>	Loans
	<b>190</b>	Simple Annual Interest
	<b>191</b>	Yield of a Discounted (or Premium) Mortgage
	<b>193</b>	Annual Percentage Rate for a Loan with Fees
	<b>195</b>	Loan with an Odd (Partial) First Period
	<b>197</b>	Canadian Mortgages
	<b>199</b>	Advance Payments (Leasing)
	<b>200</b>	Savings
	<b>200</b>	Value of a Fund with Regular Withdrawals
	<b>202</b>	Deposits Needed for a Child's College Account
	<b>206</b>	Value of a Tax-Free Account
	<b>208</b>	Value of a Taxable Retirement Account
	<b>209</b>	Modified Internal Rate of Return
	<b>213</b>	Price of an Insurance Policy
	<b>215</b>	Bonds
	<b>216</b>	Discounted Notes
	<b>217</b>	Statistics
	<b>217</b>	Moving Average
	<b>219</b>	Chi-Squared ( $\chi^2$ ) Statistics

---

<b>A</b>	<b>222</b>	<b>Assistance, Batteries, Memory, and Service</b>
	<b>222</b>	Obtaining Help in Operating the Calculator
	<b>222</b>	Answers to Common Questions
	<b>224</b>	Power and Batteries
	<b>224</b>	Low-Power Indications
	<b>225</b>	Installing Batteries
	<b>227</b>	Managing Calculator Memory
	<b>228</b>	Resetting the Calculator
	<b>230</b>	Erasing Continuous Memory
	<b>231</b>	Clock Accuracy
	<b>231</b>	Environmental Limits
	<b>231</b>	Determining If the Calculator Requires Service
	<b>232</b>	Confirming Calculator Operation: Self-Test
	<b>233</b>	Warranty
	<b>235</b>	Service
	<b>236</b>	Regulatory information
	<b>237</b>	Noise Declaration

---

<b>B</b>	<b>238</b>	<b>More About Calculations</b>
	<b>238</b>	IRR% Calculations
	<b>238</b>	Possible Outcomes of Calculating IRR%
	<b>239</b>	Halting and Restarting the IRR% Calculation
	<b>239</b>	Storing a Guess for IRR%
	<b>240</b>	Solver Calculations
	<b>240</b>	Direct Solutions
	<b>242</b>	Iterative Solutions
	<b>246</b>	Equations Used by Built-in Menus
	<b>246</b>	Actuarial Functions
	<b>247</b>	Percentage Calculations in Business (BUS)
	<b>247</b>	Time Value of Money (TVM)
	<b>247</b>	Amortization
	<b>248</b>	Interest Rate Conversions

<b>248</b>	Cash-Flow Calculations
<b>215</b>	Bond Calculations
<b>250</b>	Depreciation Calculations
<b>251</b>	Sum and Statistics
<b>251</b>	Forecasting
<b>252</b>	Equations Used in (Chapter 14)
<b>252</b>	Canadian Mortgages
<b>253</b>	Odd-Period Calculations
<b>253</b>	Advance Payments
<b>253</b>	Modified Internal Rate of Return

---

**C**      **254**      **Menu Maps**

---

<b>D</b>	<b>261</b>	<b>RPN: Summary</b>
	<b>261</b>	About RPN
	<b>261</b>	About RPN on the HP 17bII+
	<b>262</b>	Setting RPN Mode
	<b>263</b>	Where the RPN Functions Are
	<b>264</b>	Doing Calculations in RPN
	<b>264</b>	Arithmetic Topics Affected by RPN Mode
	<b>264</b>	Simple Arithmetic
	<b>266</b>	Calculations with STO and RCL
	<b>266</b>	Chain Calculations—No Parentheses!

---

<b>E</b>	<b>268</b>	<b>RPN: The Stack</b>
	<b>268</b>	What the Stack Is
	<b>269</b>	Reviewing the Stack (Roll Down)
	<b>269</b>	Exchanging the X- and Y-Registers in the Stack
	<b>270</b>	Arithmetic—How the Stack Does It
	<b>271</b>	How ENTER Works
	<b>272</b>	Clearing Numbers
	<b>273</b>	The LAST X Register
	<b>273</b>	Retrieving Numbers from LAST X

<b>273</b>	Reusing Numbers
<b>274</b>	Chain Calculations
<b>275</b>	Exercises

---

<b>F</b>	<b>276</b>	<b>RPN: Selected Examples</b>
----------	------------	-------------------------------

---

	<b>283</b>	<b>Error Messages</b>
--	------------	-----------------------

---

	<b>289</b>	<b>Index</b>
--	------------	--------------

## 12 Contents

# List of Examples

---

The following list groups the examples by category.

## **Getting Started**

- 25** Using Menus
- 29** Using the Solver

## **Arithmetic**

- 40** Calculating Simple Interest
- 178** Unit Conversions
- 190** Simple Interest at an Annual Rate  
(RPN example on page 276)

## **General Business Calculations**

- 50** Percent Change
- 51** Percent of Total
- 52** Markup as a Percent of Cost
- 52** Markup as a Percent of Price
- 53** Using Shared Variables
- 159** Return on Equity

## **Currency Exchange Calculations**

- 57** Calculating an Exchange Rate
- 58** Storing an Exchange Rate
- 59** Converting between Hong Kong and U.S Dollars

## **Time Value of Money**

- 67** A Car Loan
- 68** A Home Mortgage
- 69** A Mortgage with a Balloon Payment
- 71** A Savings Account

<b>72</b>	An Individual Retirement Account
<b>74</b>	Calculating a Lease Payment
<b>75</b>	Present Value of a Lease with Advanced Payments and Option to Buy
<b>80</b>	Displaying an Amortization Schedule for a Home Mortgage
<b>82</b>	Printing an Amortization Schedule
<b>172</b>	Calculations for a Loan with an Odd First Period
<b>191</b>	Discounted Mortgage
<b>193</b>	APR for a Loan with Fees (RPN example on page 276)
<b>194</b>	Loan from the Lender's Point of View (RPN example on page 277)
<b>196</b>	Loan with an Odd First Period
<b>197</b>	Loan with an Odd First Period Plus Balloon
<b>198</b>	Canadian Mortgage
<b>200</b>	Leasing with Advance Payments
<b>200</b>	A Fund with Regular Withdrawals
<b>202</b>	Savings for College (RPN example on page 278)
<b>207</b>	Tax-Free Account (RPN example on page 280)
<b>208</b>	Taxable Retirement Account (RPN example on page 282)
<b>214</b>	Insurance Policy

### **Interest Rate Conversions**

<b>86</b>	Converting from a Nominal to an Effective Interest Rate
<b>89</b>	Balance of a Savings Account

### **Cash Flow Calculations**

<b>97</b>	Entering Cash Flows
<b>102</b>	Calculating IRR and NPV of an Investment
<b>104</b>	An Investment with Grouped Cash Flows
<b>105</b>	An Investment with Quarterly Returns
<b>210</b>	Modified IRR

## **14 List of Examples**

	<b>Bonds and Notes</b>
<b>111</b>	Price and Yield of a Bond
<b>112</b>	A Bond with a Call Feature
<b>113</b>	A Zero-Coupon Bond
<b>215</b>	Yield to Maturity and Yield to Call
<b>217</b>	Price and Yield of a Discounted Note
	<b>Depreciation</b>
<b>117</b>	Declining-Balance Depreciation
<b>118</b>	ACRS Deductions
<b>120</b>	Partial-Year Depreciation
	<b>Running Total and Statistical Calculations</b>
<b>125</b>	Updating a Checkbook
<b>128</b>	Mean, Median, and Standard Deviation
<b>134</b>	Curve Fitting
<b>138</b>	Weighted Mean
<b>218</b>	A Moving Average in Manufacturing
<b>220</b>	Expected Throws of a Die ( $\chi^2$ )
	<b>Time, Alarms, and Date Arithmetic</b>
<b>144</b>	Setting the Date and Time
<b>148</b>	Clearing and Setting an Appointment
<b>151</b>	Calculating the Number of Days between Two Dates
<b>152</b>	Determining a Future Date
	<b>How to Use the Equation Solver</b>
<b>159</b>	Return on Equity
<b>166</b>	Sales Forecasts
<b>172</b>	Using a Solver Function (USPV)
<b>175</b>	Nested IF Functions
<b>181</b>	Using Guesses to Find a Solution Iteratively
	<b>Printing</b>
<b>189</b>	Trace-Printing an Arithmetic Calculation

# Important Information

---

- *Take the time to read chapter 1.* It gives you an overview of how the calculator works, and introduces terms and concepts that are used throughout the manual. After reading chapter 1, you'll be ready to start using all of the calculator's features.
- You can choose either ALG (Algebraic) or RPN (Reverse Polish Notation) mode for your calculations. Throughout the manual, the "✓" in the margin indicates that the examples or keystrokes must be performed differently in RPN. Appendixes D, E, and F explain how to use your calculator in RPN mode.
- Match the problem you need to solve with the calculator's capabilities and read the related topic. You can locate information about the calculator's features using the table of contents, the subject index, the list of examples, and the menu maps in appendix C (the gold-edged pages).
- Before doing any time-value-of-money or cash-flow problems, refer to pages 64 and 92 to learn how the calculator uses positive and negative numbers in financial calculations.
- For a deeper treatment of specific types of calculations, refer to chapter 14, "Additional Examples." If you especially like learning by example, this is a good reference spot for you.

## 16 Important Information



## Getting Started

---







Watch for this symbol in the margin. It identifies examples or keystrokes that are shown in ALG mode and must be performed differently in RPN mode. Appendixes D, E, and F explain how to use your calculator in RPN mode.


The mode affects only arithmetic calculations — all other operations, including the Solver, work the same in RPN and ALG modes.

---

### Power On and Off; Continuous Memory




To turn on the calculator, press  (*clear*) (note ON printed below the key). To turn it off, press  and then . This *shifted* function is called  (note OFF printed above the key). Since the calculator has *Continuous Memory*, turning it off does not affect the information you've stored there.

To conserve energy, the calculator turns itself off after 10 minutes of no use.

If you see the low battery symbol (  ) at the top of the display, you should replace the batteries as soon as possible. Follow the instructions on page 224.

---



### Adjusting the Display Contrast

The display's brightness depends on lighting, your viewing angle, and the display contrast setting. To change the display contrast, hold down the  key and press  or .







---

## Setting the Language

The calculator can display information in six different languages. The language initially used by the calculator was preset at the factory. To change the language:

1. Press the  **MODES**.
2. Press  to display the INTL menu, which stands for "international".
3. Press the appropriate menu key to change the language.

**Table 1-1. Keys for language**

Key	Description
	German
	English
	Spanish
	French
	Italian
	Portuguese

---

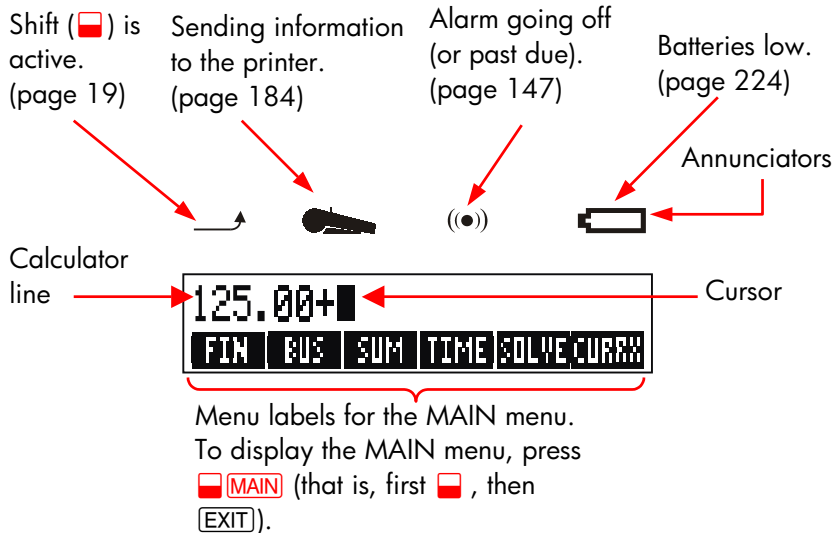
## What You See in the Display

**Menu Labels.** The bottom line of the display shows the menu labels for each of the six major menus (work areas) in the calculator. More about these later in this chapter.

**The Calculator Line.** The calculator line is where you see numbers (or letters) that you enter, and the results of calculations.

**Annunciators.** The symbols shown here are called *annunciators*. Each one has a special significance.

### 18 1: Getting Started




---

## The Shift Key ( )

Some keys have a second, *shifted* function printed in color above the key. The colored shift key accesses these operations. For example, pressing and releasing ( ), then pressing [CLR] turns the calculator off. This is written ( ) [OFF].





Pressing ( ) turns on the shift annunciator ( —↗ ). This symbol stays on until you press the next key. If you ever press ( ) by mistake, just press ( ) again to turn off the —↗.



---






## Backspacing and Clearing

The following keys erase typing mistakes, entire numbers, or even lists or sets of data.

**Table 1-2. Keys for Clearing**

Key	Description
	Backspace; erases the character before the cursor.
	Clear; clears the calculator line. (When the calculator is off, this key turns the calculator on, but <i>without</i> clearing anything.)
	This clears all information in the current work area ( <i>menu</i> ). For example, it will erase all the numbers in a list if you are currently viewing a list (SUM or CFLO). In other menus (like TVM),  clears all of the values that have been stored. In SOLVE, it can delete all equations.

The cursor ( ■ ) is visible while you are keying in a number or doing a calculation. When the cursor is visible, pressing  deletes the last character you keyed in. When the cursor is not visible, pressing  erases the last number.

<b>Keys:</b>	<b>Display:</b>	<b>Description:</b>
12345  	123.66■	Backspacing removes the 4 and 5.
.66	0.01	Calculates 1/123.66.
 	0.00	Clears the calculator line.
		

In addition, there are more drastic clearing operations that erase more information at once. Refer to “Resetting the Calculator” on page 228 in appendix A.

---

## Doing Arithmetic

The “✓” in the margin is a reminder that the example keystrokes are for ALG mode.

This is a brief introduction to doing arithmetic. More information on arithmetic is in chapter 2. Remember that you can erase errors by pressing  $\left[ \blacktriangleleft \right]$  or  $\left[ \text{CLR} \right]$ .

To calculate  $21.1 + 23.8$ :

Keys:	Display:	Description:
21.1 $\left[ + \right]$	21.10+	
23.8	21.10+23.8	
$\left[ = \right]$	44.90	$\left[ = \right]$ completes calculation.

Once a calculation has been completed, pressing another digit key *starts* a new calculation. On the other hand, pressing an operator key *continues* the calculation:

77.35 $\left[ - \right]$	77.35-	Calculates $77.35 - 90.89$
90.89 $\left[ = \right]$	-13.54	
65 $\left[ \sqrt{x} \right]$ $\left[ \times \right]$ 12		New calculation:
$\left[ = \right]$	96.75	$\sqrt{65} \times 12$ .
$\left[ \div \right]$ 3.5 $\left[ = \right]$	27.64	Calculates $96.75 \div 3.5$ .

You can also do long calculations *without* pressing  $\left[ = \right]$  after each intermediate calculation—just press it at the end. The operators perform from left to right, in the order you enter them. Compare:

$\frac{65 + 12}{3.5}$	and	$65 + \frac{12}{3.5}$	
65 $\left[ + \right]$ 12 $\left[ \div \right]$			Operations occur in the
3.5 $\left[ = \right]$	22.00		order you see them.

65  $\boxed{+}$   $\boxed{C}$  12  $\boxed{\div}$   
3.5  $\boxed{)}$   $\boxed{=}$  68.43

Use parentheses to impose  
an order of calculation.

---

## Keying in Negative Numbers ( $\boxed{+/-}$ )

The  $\boxed{+/-}$  key *changes the sign* of a number.

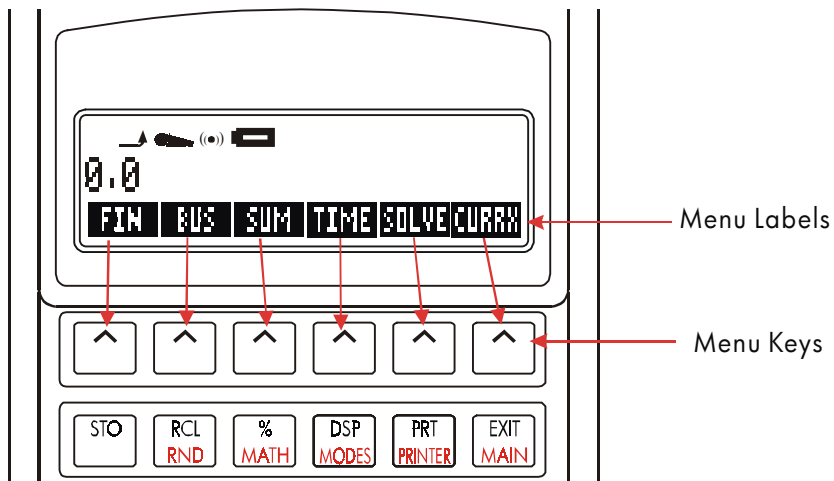
- To key in a negative number, type that number, then press  $\boxed{+/-}$ .
- To change the sign of an already displayed number (it must be the rightmost number), press  $\boxed{+/-}$ .

Keys:	Display:	Description:
75 $\boxed{+/-}$	-75	Changes the sign of 75.
✓ $\boxed{\times}$ 7.1 $\boxed{=}$	-532.50	Multiplies -75 by 7.1.

---


## Using the Menu Keys

The calculator usually displays a set of labels across the bottom of the display. The set is called a *menu* because it presents you with choices. The MAIN menu is the starting point for all other menus.



The top row of keys is related to the labels along the bottom of the display. The labels tell you what the keys do. The six keys are called *menu keys*; the labels are called *menu labels*.

## The MAIN Menu

The MAIN menu is a set of primary choices leading to other menu options. No matter which menu you currently see, pressing  **MAIN** redisplay the MAIN menu. The menu structure is *hierarchical*.

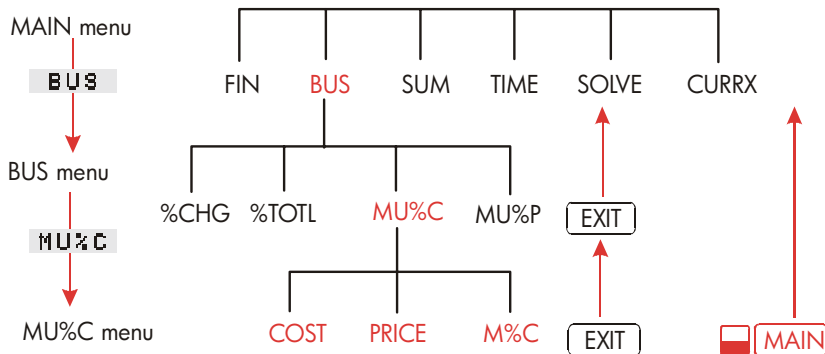
**Table 1-3. The MAIN Menu**

<b>Menu Label</b>	<b>Operations Done in This Category</b>	<b>Covered in:</b>
<b>FIN</b> (Finance)	TVM: Time value of money: loans, savings, leasing, amortization. ICNV: Interest conversions. CFLO: Lists of cash flows for internal rate of return and net present value. BOND: Yields and prices for bonds. DEPRC: Depreciation using SL, DB, and SOYD methods, or ACRS.	Chapter 5 Chapter 6 Chapter 7 Chapter 8 Chapter 9
<b>BUS</b> (Business Percentages)	Percent of total, percent change, markup on cost, markup on price.	Chapter 3
<b>SUM</b> (Statistics)	Lists of numbers, running total, mean, weighted statistics, forecasting, summation statistics, and more.	Chapter 10
<b>TIME</b> (Time Manager)	Clock, calendar, appointments, date arithmetic.	Chapter 11
<b>SOLVE</b> (Equation Solver)	Creates customized menus from your own equations for calculations you do often.	Chapter 12
<b>CURRX</b> (Currency Exchange)	Converting any currency to its equivalent in another currency	Chapter 4



## Choosing Menus and Reading Menu Maps

Below is a *menu map* illustrating one possible path through three levels of menus: from the MAIN menu to the BUS menu to the MU%*C* (*markup as a percent of cost*) menu. There are no menus that branch from the MU%*C* menu because the MU%*C* menu is a final destination—you use it to do calculations, rather than to choose another menu.



- Press **BUS** to choose the BUS menu. Then press **MU% C** to choose the MU%*C* menu.
- Press **EXIT** to return to the previous menu. Pressing **EXIT** enough times returns you to the MAIN menu.
- Press **MAIN** to return to the MAIN menu directly.




When a menu has more than six labels, the label **MORE** appears at the far right. Use it to switch between sets of menu labels on the same “level”.

**Example: Using Menus.** Refer to the menu map for MU%*C* (above) along with this example. The example calculates the percent markup on cost of a crate of oranges that a grocer buys for \$4.10 and sells for \$4.60.

- Step 1.** Decide which menu you want to use. The MU%*C* (markup as a percent of cost) menu is our destination. If it’s not obvious to you which menu you need, look up the topic in the subject

index and examine the menu maps in appendix C.

### Displaying the MU%C menu:



- Step 2.** To display the MAIN menu, press  **MAIN**. This step lets you start from a known location on the menu map.
- Step 3.** Press  to display the BUS menu.
- Step 4.** Press  to display the MU%C menu.

### Using the MU%C menu:

- Step 5.** Key in the cost and press  to store 4.10 as the *COST*.





```
COST=4.10
COST PRICE M%C
```

- Step 6.** Key in the price and press  to store 4.60 as the *PRICE*.
- Step 7.** Press  to calculate the markup as a percent of cost. The answer: *MARKUP%C=12.20*.



```
MARKUP%C=12.20
COST PRICE M%C
```

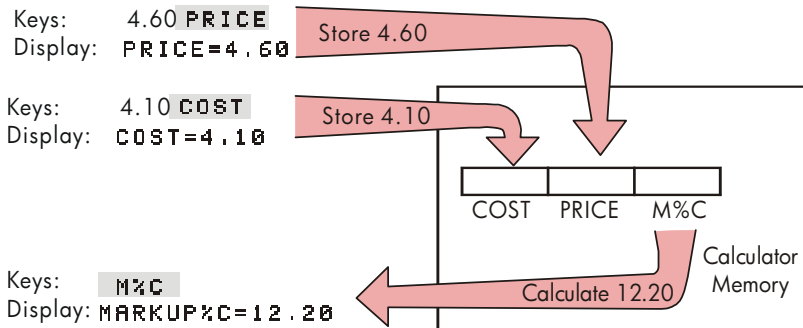
- Step 8.** To leave the MU%C menu, press  twice (once to get back to the BUS menu, and again to get to the MAIN menu) or  **MAIN** (to go directly to the MAIN menu).

## 26 1: Getting Started

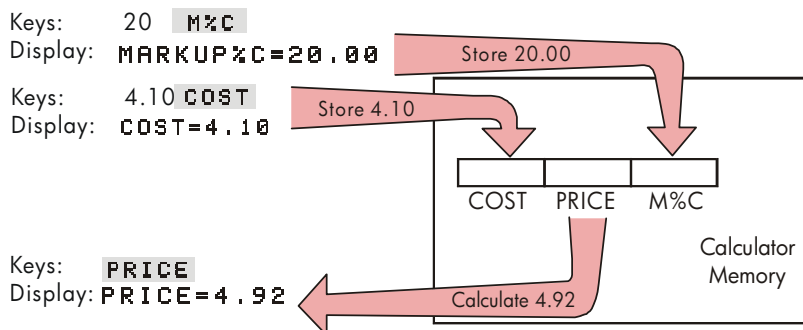
## Calculations Using Menus

Using menus to do calculations is easy. You don't have to remember in what order to enter numbers and in what order results come back. Instead, the menu guide you, as in the previous example. All the keys you need are together in the top row. The menu keys both store numbers for the calculations and start the calculations.

The MU%**C** menu can calculate *M%**C***, the percent markup on cost, given *COST* and *PRICE*.



Then the same menu can calculate *PRICE* given *COST* and *M%**C***.



Notice that the two calculations use the same three variables; each variable can be used both to store and calculate values. These are called *built-in variables*, because they are permanently built into the calculator.

Many menus in this calculator work like the example above. The rules for using variables are:

- **To store a value**, key in the number and press the menu key.\*† Arithmetic calculations, as well as single values, can be stored.
- **To calculate a value**, press the menu key without first keying in a number. The calculator displays `CALCULATING...` when a value is being calculated.
- **To verify a stored value**, press `RCL` (*recall*) followed by the menu key. For example, `RCL COST` displays the value stored in `COST`.
- **To transfer a value to another menu**, do nothing if it is displayed (that is, it is in the calculator line). A number in the calculator line remains there when you switch menus. To transfer more than one value from a menu, use storage registers. See page 45, "Storing and Recalling Numbers."

## Exiting Menus (`EXIT`)

The `EXIT` key is used to leave the current menu and go back to the previously displayed menu (as shown in the previous example). This is true for menus you might pick by accident, too: `EXIT` gets you out.

## Clearing Values in Menus


The `CLR DATA` key is a powerful feature to clear all the data in the currently displayed menu, giving you a clean slate for new calculations.


- If the current menu has variables (that is, if the display shows menu labels for variables, such as `COST`, `PRICE`, and `M%C` in the `MU%C` menu), pressing `CLR DATA` clears the values of those variables to zero.

\* If you have just switched menus and want to store the result already in the calculator line, then you should press `STO` before the menu key

† To store the same number into two different variables, use `STO` for the second variable, e.g. `25 PRICE STO COST`

## 28 1: Getting Started

- If the current menu has a list (SUM, CFLO, or Solver), pressing  clears the values in the list.

To see what value is currently stored in a variable, press  *menu label*.

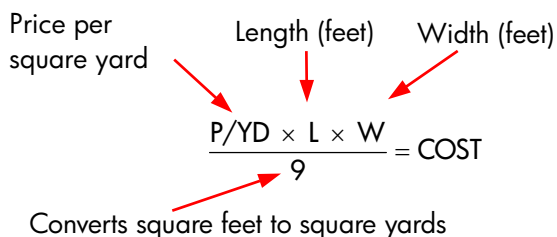
---

## Solving Your Own Equations (SOLVE)

This chapter has introduced some of the built-in menus the calculator offers. But if the solution to a problem is not built into HP 17bII+, you can turn to the most versatile feature of all: *the Equation Solver*. Here you define your own solution in terms of an equation. The Solver then creates a menu to go with your equation, which you can use over and over again, just like the other menus in the calculator.

The Solver is covered in chapter 12, but here is an introductory example. Because equations usually use letters of the alphabet, this section also explains how to type and edit letters and other characters that aren't on the keyboard.

**Example:Using the Solver.** Suppose you frequently buy carpet and must calculate how much it will cost. The price is quoted to you per square yard. Regardless of how you do the calculation (even if you do it longhand), you are using an equation.



Price per square yard      Length (feet)      Width (feet)

$$\frac{P/YD \times L \times W}{9} = \text{COST}$$

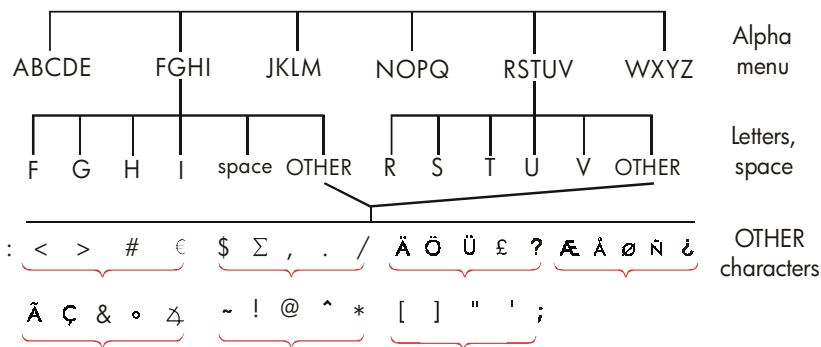
Converts square feet to square yards

To type this equation into the Solver, use the ALPHA menu.

## Typing Words and Characters: the ALPHAbetic Menu

The ALPHAbetic menu is automatically displayed when you need it to type letters and characters. The ALPHA menu also includes characters not found on the keyboard:

- Uppercase letters.
- Space.
- Punctuation and special characters.
- Non-English letters.



To type a letter you need to press two keys; for example, Å is produced by the keystrokes **ABCDE** **Å** .

Each letter menu has an **OTHER** key for accessing punctuation and non-English characters. The letter menus with just four letters (for example, FGHI) include a space character (  ).

To familiarize yourself with the ALPHA menu, type in the equation for the cost of carpeting. The necessary keystrokes are shown below. (Note the access to the special character, "/".) Use **↩**, if necessary, to make corrections. If you need to do further editing, refer to the next section, "Editing ALPHAbetic Text." When you're satisfied that the equation is correct, press **INPUT** to enter the equation into memory.

### 30 1: Getting Started

## Keys

MAIN

SOLVE	NEW		
NOPQ	P		
WXYZ	OTHER	MORE	/
WXYZ	Y	ABCDE	D
JKLM	L		
WXYZ	W		
ABCDE	C	NOPQ	O
RSTUV	S	RSTUV	T
INPUT			

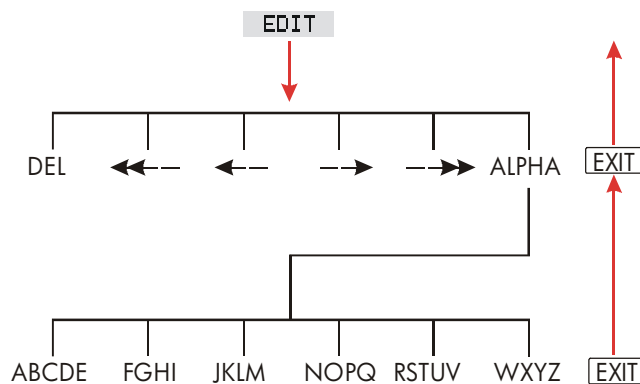
## Characters

P  
P/  
P/YD  
P/YD×L×  
P/YD×L×W÷9=  
P/YD×L×W÷9=C0  
P/YD×L×W÷9=COST  
P/YD×L×W÷9=COST

Note that the / is just a character, part of the variable's name. It is *not* an operator, which ÷ is.

## Editing ALPHAbetic Text

The companion to the ALPHA menu is the ALPHA-Edit menu. To display the ALPHA-Edit menu, press **EDIT** in the SOLVE menu (or press **EXIT** in the ALPHA menu).



**Table 1-4. Alphabetic Editing**

Operation	Label or Key to Press
<b>ALPHA-Edit Menu</b>	
Inserts character before the cursor.	Any character.
Deletes character at the cursor.	DEL
Moves the cursor far left, one display-width.	<<←
Moves the cursor left.	←
Moves the cursor right.	→
Moves the cursor far right, one display-width.	→>>
Displays the ALPHA menu again.	ALPHA
<b>Keyboard</b>	
Backspaces and erases the character before the cursor.	◀
Clears the calculator line.	CLR

## Calculating the Answer (CALC)

After an equation is input, pressing **CALC** verifies it and creates a new, customized menu to go with the equation.



Menu labels for your variables

Each of the variables you typed into the equation now appears as a menu label. You can store and calculate values in this menu the same way you do in other menus.

## 32 1: Getting Started





Calculate the cost of carpet needed to cover a 9' by 12' room. The carpet costs \$22.50 per square yard.

Starting from the MAIN menu (press  **MAIN**):

<b>Keys:</b>	<b>Display:</b>	<b>Description:</b>
<b>SOLVE</b>	$P/YD \times L \times W \div 9 = COST$	Displays the SOLVE menu and the current equation.*
<b>CALC</b>		Displays the customized menu for carpeting.
22.5 <b>P/YD</b>	$P/YD = 22.50$	Stores the price per square yard in $P/YD$ .
12 <b>L</b>	$L = 12.00$	Stores the length in $L$ .
9 <b>W</b>	$W = 9.00$	Stores the width in $W$ .
<b>COST</b>	$COST = 270.00$	Calculates the cost to cover a 9' x 12' room.

Now determine the most expensive carpet you can buy if the maximum amount you can pay is \$300. *Notice that all you need to do is enter the one value you are changing*—there is no need to re-enter the other values.

300 <b>COST</b>	$COST = 300.00$	Stores \$300 in $COST$ .
<b>P/YD</b>	$P/YD = 25.00$	Calculates the maximum price per square yard you can pay.
<b>EXIT</b> <b>EXIT</b>		Exits Solver.

\* If you entered this equation but don't see it now, press  or  until you do.

---

## Controlling the Display Format

The DSP menu (press **[DSP]**) gives you options for formatting numbers. You can pick the number of decimal places to be displayed, and whether to use a comma or a period to “punctuate” your numbers.



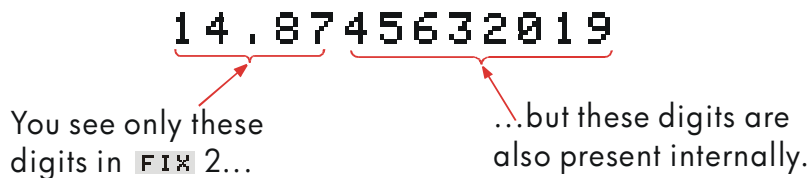
### Decimal Places

To change the number of displayed decimal places, first press the **[DSP]** key. Then either:

- Press **[FIX]**, type the number of decimal places you want (from 0 to 11), and press **[INPUT]**; or
- Press **[ALL]** to see a number as precisely as possible at any time (12 digits maximum).

### Internal Precision

Changing the number of displayed decimal places affects what you see, but does not affect the internal representation of numbers. The number inside the calculator always has 12 digits.




### Temporarily SHOWing ALL












To temporarily see a number with full precision, press **[SHOW]**. This shows you the ALL format for as long as you hold down **[SHOW]**.

## 34 1: Getting Started

## Rounding a Number






The  **RND** function rounds the number in the calculator line to the number of displayed decimal places. Subsequent calculations use the rounded value.

Starting with two displayed decimal places:

Keys:	Display:	Description:
5.787	5.787■	
 <b>DSP</b>  <b>FIX</b>		
4  <b>INPUT</b>	5.7870	Four decimal places are displayed.
 <b>DSP</b>  <b>ALL</b>	5.787	All significant digits; trailing zeros dropped.
 <b>DSP</b>  <b>FIX</b>		
2  <b>INPUT</b>	5.79	Two decimal places are displayed.
 <b>SHOW</b> (hold)	<b>FULL PRECISION IS:</b> 5.787	Temporarily shows full precision.
 <b>RND</b>		
 <b>SHOW</b> (hold)	5.79	Rounds the number to two decimal places.

## Exchanging Periods and Commas in Numbers

To exchange the periods and commas used for the decimal point and digit separators in a number:

1. Press  **DSP** to access the DSP (*display*) menu.
2. Specify the decimal point by pressing  or . Pressing  sets a period as the decimal point and comma as the digit separator (U.S. mode). (For example, 1,000,000.00.) Pressing  sets a comma as the decimal point and period as the digit separator (non-U.S. mode). (For example, 1.000.000,00.)

---

## Error Messages

Sometimes the calculator cannot do what you “ask”, such as when you press the wrong key or forget a number for a calculation. To help you correct the situation, the calculator beeps and displays a message.

- Press **CLR** or **⏏** to clear the error message.
- Press any other key to clear the message *and* perform that key’s function.

For more explanations, refer to the list of error messages just before the subject index.

---

## Modes

**Beeper.** Beeping occurs when a wrong key is pressed, when an error occurs, and during alarms for appointments. You can suppress and reactivate the beeper in the MODES menu as follows:

1. Press **MODES**.
2. Pressing **BEEP** will simultaneously change and display the current setting for the beeper:
  - **BEEPER ON** beeps for errors and appointments.
  - **BEEPER ON: APPTS ONLY** beeps only for appointments.
  - **BEEPER OFF** silences the beeper completely.
3. Press **EXIT** when done.


**Print.** Press **MODES** **PRNT** to specify whether or not the printer adapter is in use. Then press **EXIT**.

**Double Space.** Press **MODES** **DBL** to turn double-spaced printing on or off. Then press **EXIT**.

**Algebraic.** Press **MODES** **ALG** to select algebraic entry logic.


**RPN.** Press **MODES** **RPN** to select Reverse Polish Notation entry logic.

## 36 1: Getting Started

**Language.** Press  INTL to change the language.

---

## Calculator Memory ()

The calculator stores many different types of information in its memory. Each piece of information requires a certain amount of storage space.\* You can monitor the amount of *available memory* by pressing .



A rectangular box representing a calculator display. Inside the box, the text reads: "AVAILABLE MEMORY:" on the top line, "30,740 BYTES" on the second line, and "100%" on the third line. Two red arrows point from the text below to the display: one points to "30,740 BYTES" and the other points to "100%".

Number of bytes of  
memory still free

Percentage of total  
memory still free

The amount of memory available for storing information and working problems is about 30,740 bytes. (Units of memory space are called *bytes*.) The calculator gives you complete flexibility in how you use that available memory (such as for lists of numbers or equations). Use as much of the memory as you want for any task you want.

If you use nearly all of the calculator's memory, you'll encounter the message **INSUFFICIENT MEMORY**. To remedy this situation, you must erase some previously stored information. Refer to "Managing Calculator Memory" on page 227 in appendix A.

The calculator also allows you to erase at once *all* the information stored inside it. This procedure is covered in "Erasing Continuous Memory" on page 230.

\* Storing numbers in menus like TVM (non-Solver menus) does *not* use any of your memory space.

# 2

## Arithmetic

---

If you prefer RPN to algebraic logic, please read appendix D before you read this chapter. The “✓” in the margin is a reminder that the example keystrokes are for ALG mode.

---

### The Calculator Line

The calculator line is the part of the display where numbers appear and calculations take place. Sometimes this line includes labels for results, such as TOTAL=124.60. Even in this case you can use the number ✓ for a calculation. For example, pressing  $\boxed{+}$  2  $\boxed{=}$  would calculate 124.60 plus 2, and the calculator would display the answer, 126.60.

There is always a number in the calculator line, even though sometimes the calculator line is hidden by a message (such as SELECT COMPOUNDING). To see the number in the calculator line, press  $\boxed{\blacktriangleleft}$ , which removes the message.

---

### ✓ Doing Calculations

Simple calculating was introduced in chapter 1, page 21. Often longer calculations involve more than one operation. These are called *chain calculations* because several operations are “chained” together. To do a chain calculation, you don’t need to press  $\boxed{=}$  after each operation, but only at the very end.

For instance, to calculate  $\frac{750 \times 12}{360}$  you can type either:

750  $\boxed{\times}$  12  $\boxed{=}$   $\boxed{\div}$  360  $\boxed{=}$

or

750  $\boxed{\times}$  12  $\boxed{\div}$  360  $\boxed{=}$

In the second case, the  $\div$  key acts like the  $=$  key by displaying the result of  $750 \times 12$ .

Here's a longer chain calculation.

$$\frac{456 - 75}{18.5} \times \frac{68}{1.9}$$

This calculation can be written as:  $456 - 75 \div 18.5 \times 68 \div 1.9$ .  
Watch what happens in the display as you key it in:

Keys:	Display:
456 $=$ 75 $\div$	381.00 $\div$
18.5 $\times$	20.59 $\times$
68 $\div$	1,400.43 $\div$
1.9 $=$	737.07

## ✓ Using Parentheses in Calculations

Use parentheses when you want to postpone calculating an intermediate result until you've entered more numbers. For example, suppose you want to calculate:

$$\frac{30}{85 - 12} \times 9$$

If you were to key in  $30 \div 85 =$ , the calculator would calculate the intermediate result, 0.35. However, that's not what you want. To delay the division until you've subtracted 12 from 85, use parentheses:

Keys:	Display:	Description:
30 $\div$ ( 85 $=$	30.00 $\div$ (85.00-	No calculation is done.
12 $)$	30.00 $\div$ 73.00	Calculates $85 - 12$ .
$\times$ 9	0.41 $\times$ 9	Calculates $30 / 73$ .
$=$	3.70	Calculates $0.41 \times 9$ .

Note that you must include a  $\times$  for multiplication; parentheses do *not* imply multiplication.

---

## ✓ The Percent Key

The  $\%$  key has two functions:

**Finding a Percentage.** In most cases,  $\%$  divides a number by 100. The one exception is when a plus or minus sign precedes the number. (See “Adding or Subtracting a Percentage,” below.)

For instance, 25  $\%$  results in 0.25.

To find 25% of 200, press: 200  $\times$  25  $\%$   $=$ . (Result is 50.00.)

**Adding or Subtracting a Percentage.** You can do this all in one calculation:

For instance, to decrease 200 by 25%, just enter 200  $-$  25  $\%$   $=$ . (Result is 150.00.)

**Example: Calculating Simple Interest.** You borrow \$1,250 from a relative, and agree to repay the loan in a year with 7% simple interest. How much money will you owe?

Keys:	Display:	Description:
1250 $+$ 7 $\%$	1,250.00+87.50	Interest on the loan is \$87.50.
$=$	1,337.50	You must repay this amount at the end of one year.

---




## The Mathematical Functions








Some of the math functions appear on the keyboard; others are in the MATH menu. Math functions act on the last number in the display.

### 40 2: Arithmetic









**Table 2-1. Shifted Math Functions**

Key	Description
	reciprocal
	square root
	square



Keys:	Display:	Description:
4 	0.25	Reciprocal of 4.
20 	4.47	Calculates $\sqrt{20}$ .
✓  47.2 	51.67x	Calculates 4.47 + 47.20.
✓ 1.1  	51.67x1.21	Calculates 1.1 <sup>2</sup> .
✓ 	62.52	Completes calculation of (4.47 + 47.2) x 1.1 <sup>2</sup> .

✓ **The Power Function (Exponentiation)**







The power function, , raises the preceding number to the power of the following number.

Keys:	Display:	Description:
125  3 	1.953,125.00	Calculates 125 <sup>3</sup> .
125  3		Calculates the cube root of 125, which is the same as (125) <sup>1/3</sup> .
 	5.00	

## The MATH Menu

To display the MATH menu, press  **MATH** (the shifted  key). Like the other mathematics functions, these functions operate on only the last number in the display.


**Table 2-2. The MATH Menu Labels**

Menu Label	Description
 LOG	Common (base 10) logarithm of a positive number.
 10 <sup>X</sup>	Common (base 10) antilogarithm; calculates 10 <sup>x</sup> .
 LN	Natural (base e) logarithm of a positive number.
 EXP	Natural antilogarithm; <i>calculates</i> e <sup>x</sup> .
 N!	Factorial.
 PI	Inserts the value for $\pi$ into the display.

**Keys:**

2.5  **MATH**

 10<sup>X</sup>

4  N!

 EXIT

**Display:**

316.23



24.00

**Description:**

Calculates 10<sup>2.5</sup>.

Calculates the factorial of 4.

Exits MATH menu.

You can access the MATH menu when another menu is displayed. For instance, while using SUM you might want to use a MATH function. Just press  **MATH**, then perform the calculation. Pressing  returns you to SUM. The MATH result remains in the calculator line. Remember, however, that you must exit MATH before you resume using SUM.

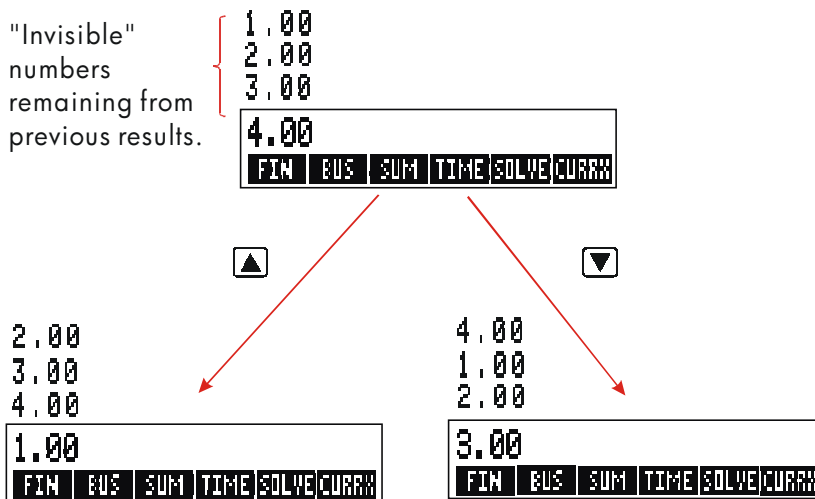
---

## Saving and Reusing Numbers

Sometimes you might want to include the result of a previous calculation in a new calculation. There are several ways to reuse numbers.



### The History Stack of Numbers





When you start a new operation, the previous result moves out of the display *but is still accessible*. Up to four lines of numbers are saved: one in the display and three hidden. These lines make up the *history stack*.



The  $\blacktriangledown$ ,  $\blacktriangle$ , and  $\text{R}\downarrow$  keys "roll" the history stack down or up one line, bringing the hidden results back into the display. If you hold down  $\blacktriangle$  or  $\blacktriangledown$ , the history stack wraps around on itself. However, you cannot roll the history stack when an incomplete calculation is in the display. Also, you cannot gain access to the stack while using lists (SUM, CFLO) in ALG mode, or SOLVE in either ALG or RPN mode. All numbers in the history stack are retained when you switch menus.

Pressing  $\text{R}\leftrightarrow$  exchanges the contents of the bottom two lines of the display.


Pressing  clears the history stack. Be careful if a menu is active, because then  also erases the data associated with that menu.

<b>✓ Keys:</b>	<b>Display:</b>	<b>Description:</b>
75.55  32.63		
	42.92	
150  7 	21.43	42.92 moves out of display.










Now, suppose you want to multiply 42.92 x 11. Using the history stack saves you time.

	42.92	Moves 42.92 back to calculator line.
 11 	472.12	

### ✓ Reusing the Last Result ( **LAST**)

The  **LAST** key copies the last result—that is, the number just above the calculator line in the history stack—into a current calculation. This lets you reuse a number without retyping it and also lets you break up a complicated calculation.

$$\frac{39 + 8}{\sqrt{123 + 17}}$$

<b>Keys:</b>	<b>Display:</b>	<b>Description:</b>
123  17 	140.00	Calculates 123 + 17.
 	11.83	Calculates $\sqrt{140}$ .
39  8  		Copies 11.83 to the calculator line.
 <b>LAST</b>	47.00 ÷ 11.83	
	3.97	Completes the calculation.

## 44 2: Arithmetic

An equivalent keystroke sequence for this problem would be:

39  $\boxed{+}$  8  $\boxed{\div}$   $\boxed{C}$  123  $\boxed{+}$  17  $\boxed{C}$   $\boxed{\sqrt{x}}$   $\boxed{=}$

## Storing and Recalling Numbers

The  $\boxed{\text{STO}}$  key copies a number from the calculator line into a designated storage area, called a *storage register*. There are ten storage registers in calculator memory, numbered 0 through 9. The  $\boxed{\text{RCL}}$  key recalls stored numbers back to the calculator line.

- ✓ If there is more than one number on the calculator line,  $\boxed{\text{STO}}$  stores only the last number in the display.

To store or recall a number:

1. Press  $\boxed{\text{STO}}$  or  $\boxed{\text{RCL}}$ . (To cancel this step, press  $\boxed{\blacktriangleleft}$ .)
2. Key in the register number.

The following example uses two storage registers to do two calculations that use some of the same numbers.

$$\frac{475.6}{39.15}$$

$$\frac{560.1 + 475.6}{39.15}$$

✓ Keys:	Display:	Description:
475.6 $\boxed{\text{STO}}$ 1	475.60	Stores 475.6 into register 1.
$\boxed{\div}$ 39.15 $\boxed{\text{STO}}$ 2	475.60 $\div$ 39.15	Stores 39.15 (rightmost number) into register 2.
$\boxed{=}$	12.15	Completes calculation.
560.1 $\boxed{+}$ $\boxed{\text{RCL}}$ 1	560.10+475.60	Recalls contents of register 1.
$\boxed{\div}$ $\boxed{\text{RCL}}$ 2	1,035.70 $\div$ 39.15	Recalls register 2.
$\boxed{=}$	26.45	Completes calculation.

The **STO** and **RCL** keys can also be used with variables. For example, **STO** **M%*C*** (in the MU%*C* menu) stores the rightmost number from the display into the variable *M%*C**. **RCL** **M%*C*** copies the contents of *M%*C** into the calculator line. If there is an expression in the display (such as  $2+4=$ ), then the recalled number replaces only the last number.

You do not need to clear storage registers before using them. By storing a number into a register, you overwrite whatever existed there before.

### Doing Arithmetic Inside Registers and Variables

You can also do arithmetic inside storage registers.

Keys:	Display:	Description:
45.7 <b>STO</b> 3	45.70	Stores 45.7 in reg. 3.
2.5 <b>STO</b> <b>×</b> 3	2.50	Multiplies contents of register 3 by 2.5 and stores result (114.25) back in register 3.
<b>RCL</b> 3	114.25	Displays register 3.

**Table 2-3. Arithmetic in Registers**

Keys	New Register Contents
<b>STO</b> <b>+</b>	old register contents + displayed number
<b>STO</b> <b>-</b>	old register contents - displayed number
<b>STO</b> <b>×</b>	old register contents x displayed number
<b>STO</b> <b>÷</b>	old register contents ÷ displayed number
<b>STO</b> <b>y<sup>x</sup></b>	old register contents ^ displayed number

## 46 2: Arithmetic

You can also do arithmetic with the values stored in variables. For example, 2  $\boxed{\text{STO}} \boxed{\times} \boxed{M\%C}$  (in the MU%C menu) multiplies the current contents of M%C by 2 and stores the product in M%C.

## Scientific Notation

Scientific notation is useful when working with very large or very small numbers. Scientific notation shows a small number (less than 10) times 10 raised to a power. For example, the 1984 Gross National Product of the United States was \$3,662,800,000,000. In scientific notation, this is  $3.6628 \times 10^{12}$ . For very small numbers the decimal point is moved to the right and 10 is raised to a negative power. For example, 0.00000752 can be written as  $7.52 \times 10^{-6}$ .

When a calculation produces a result with more than 12 digits, the number is automatically displayed in scientific notation, using a capital E in place of "x10^".

Remember that  $\boxed{+/-}$  changes the sign of the entire number, and not of the exponent. Use  $\boxed{-}$  to make a negative exponent.

Type in the numbers  $4.78 \times 10^{13}$  and  $-2.36 \times 10^{-15}$ .

<b>Keys:</b>	<b>Display:</b>	<b>Description:</b>
4.78 $\boxed{\text{E}}$ 13	4.78E13	Pressing $\boxed{\text{E}}$ starts the exponent.
$\boxed{\text{CLR DATA}}$	0.00	Clears number.
2.36 $\boxed{\text{E}} \boxed{-}$ 15	2.36E-15	Pressing $\boxed{-}$ before an exponent makes it negative.
$\boxed{+/-}$	-2.36E-15	Pressing $\boxed{+/-}$ makes the entire number negative.
$\boxed{\text{CLR DATA}}$		Clears number.

---

## Range of Numbers

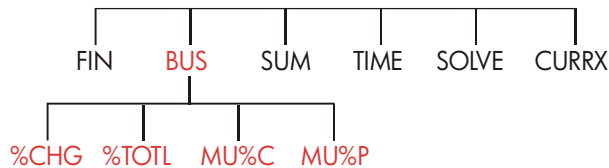
The largest positive and negative numbers available on the calculator are  $\pm 9.9999999999 \times 10^{499}$ ; the smallest positive and negative numbers available are  $\pm 1 \times 10^{-499}$ .



# 3



## Percentage Calculations in Business


The business percentages (BUS) menu is used to solve four types of problems. Each type of problem has its own menu.



**Table 3-1. The Business Percentages (BUS) Menus**

Menu	Description
Percent change ( <code>%CHG</code> )	The difference between two numbers ( <i>OLD</i> and <i>NEW</i> ), expressed as a percentage ( <i>%CH</i> ) of <i>OLD</i> .
Percent of total ( <code>%TOTL</code> )	The portion that one number ( <i>PART</i> ) is of another ( <i>TOTAL</i> ), expressed as a percentage ( <i>%T</i> ).
Markup on cost ( <code>MU%C</code> )	The difference between price ( <i>PRICE</i> ) and cost ( <i>COST</i> ), expressed as a percentage of the cost ( <i>M%C</i> ).
Markup on price ( <code>MU%P</code> )	The difference between price ( <i>PRICE</i> ) and cost ( <i>COST</i> ), expressed as a percentage of the price ( <i>M%P</i> ).



The calculator retains the values of the BUS variables until you clear them by pressing  **CLR DATA**. For example, pressing  **CLR DATA** while in the %CHG menu clears *OLD*, *NEW*, and %CH.

To see what value is currently stored in a variable, press  **RCL** menu label. This shows you the value without recalculating it.

---

## Using the BUS Menus

Each of the four BUS menus has three variables. You can calculate any one of the three variables if you know the other two.

1. To display the %CHG, %TOTL, MU%C, or MU%P menu from the MAIN menu, press  **BUS**, then the appropriate menu label. Pressing  **%CHG**, for example, displays:



2. Store each value you know by keying in the number and pressing the appropriate menu key.
3. Press the menu key for the value you want to calculate.

---

## Examples Using the BUS Menus

### Percent Change (%CHG)

**Example.** Total sales last year were \$90,000. This year, sales were \$95,000. What is the percent change between last year's sales and this year's?

Keys:	Display:	Description:
 		Displays %CHG menu.

### 50 3: Percentage Calculations in Business

90000	<b>OLD</b>	OLD=90,000.00	Stores 90,000 in <i>OLD</i> .
95000	<b>NEW</b>	NEW=95,000.00	Stores 95,000 in <i>NEW</i> .
<b>%CH</b>		%CHANGE=5.56	Calculates percent change.

What would this year's sales have to be to show a 12% increase from last year? *OLD* remains 90,000, so you don't have to key it in again. Just enter *%CH* and ask for *NEW*.

12	<b>%CH</b>	%CHANGE=12.00	Stores 12 in <i>%CH</i> .
<b>NEW</b>		NEW=100,800.00	Calculates the value 12% greater than 90,000.

### Percent of Total (%TOTL)

**Example.** Total assets for your company are \$67,584, The firm has inventories of \$23,457. What percentage of total assets is inventory?

You will be supplying values for *TOTAL* and *PART* and calculating *%T*. This takes care of all three variables, so there is no need to use **CLR DATA** to remove old data.

<b>Keys:</b>	<b>Display:</b>	<b>Description:</b>
<b>BUS</b> <b>%TOTL</b>		Displays %TOTL menu.
67584 <b>TOTAL</b>	TOTAL=67,584.00	Stores \$67,584 in <i>TOTAL</i> .
23457 <b>PART</b>	PART=23,457.00	Stores \$23,457 in <i>PART</i> .
<b>%T</b>	%TOTAL=34.71	Calculates percent of total.

## Markup as a Percent of Cost (MU%C)

**Example.** The standard markup on costume jewelry at Balkis's Boutique is 60%. The boutique just received a shipment of chokers costing \$19.00 each. What is the retail price per choker?

Keys:	Display:	Description:
BUS		Displays MU%C menu.
MU%C		
19	COST	Stores cost in <i>COST</i> .
60	MU%C	Stores 60% in <i>MU%C</i> .
PRICE	PRICE=30.40	Calculates price.

## Markup as a Percent of Price (MU%P)

**Example.** Kilowatt Electronics purchases televisions for \$225, with a discount of 4%. The televisions are sold for \$300. What is the markup of the net cost as a percent of the selling price?

What is the markup as percent of price without the 4% discount?

Keys:	Display:	Description:
BUS		Displays MU%P menu.
MU%P		
✓ 225		Calculates and stores net cost in <i>COST</i> .
4		
⊖		
Ⓜ		
COST	COST=216.00	
300	PRICE	Stores 300 in <i>PRICE</i> .
MU%P	MARKUP%P=28.00	Calculates markup as a percent of price.

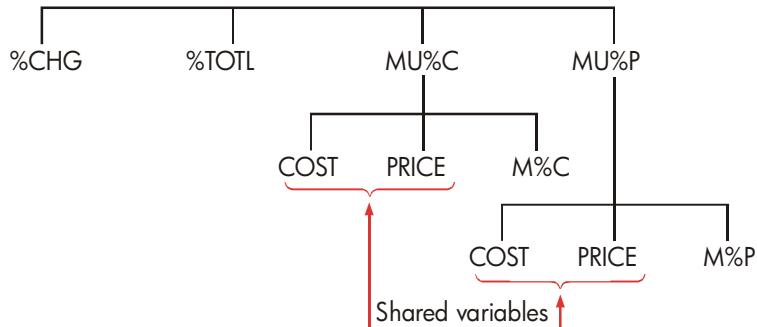
Use \$225 for *COST* and leave *PRICE* alone.

225	COST	COST=225.00	Stores 225 in <i>COST</i> .
MU%P	MARKUP%P=25.00		Calculates markup.

## 52 3: Percentage Calculations in Business

## Sharing Variables Between Menus

If you compare the MU%**C** menu and the MU%**P** menus, you'll see that they have two menu labels in common — **COST** and **PRICE**.



The calculator keeps track of the values you key in according to those labels. For example, if you key in *COST* and *PRICE* in the MU%**C** menu, exit to the BUS menu, and then display the MU%**P** menu, the calculator retains those values. In other words, the variables are *shared* between the two menus.

**Example: Using Shared Variables.** A food cooperative buys cases of canned soup with an invoice cost of \$9.60 per case. If the co-op routinely uses a 15% markup on cost, for what price should it sell a case of soup?

### Keys:

**BUS** **MU%C**  
 9.6 **COST**  
 15 **M%C**  
**PRICE**

### Display:

**COST=9.60**  
**MARKUP%C=15.00**  
**PRICE=11.04**

### Description:

Displays MU%**C** menu.  
 Stores 9.60 in **COST**.  
 Stores 15% in **M%C**.  
 Calculates retail price.

What is the markup on price? Switch menus but keep the same *COST* and *PRICE*.

**EXIT** **MU%P**

**M%P**

**MARKUP%P=13.04**

Exits MU%**C** menu and displays MU%**P** menu.  
 Calculates markup as a percent of price.

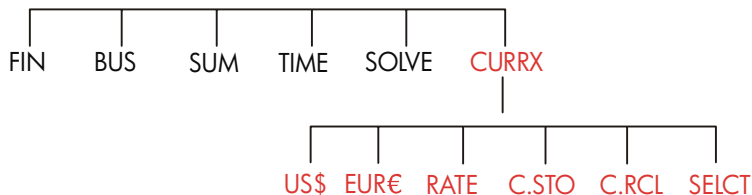
## 3: Percentage Calculations in Business 53

# 4

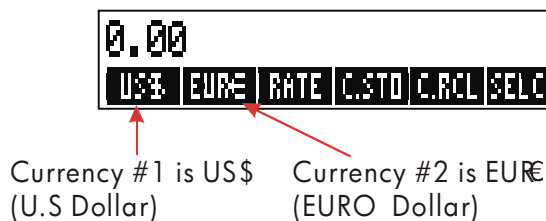
## Currency Exchange Calculations

The CURRX menu does currency exchange calculations between two currencies using an exchange rate that you calculate or store.

### The CURRX Menu



To display the currency exchange menu from the MAIN menu, press **CURRX**.



### 54 4: Currency Exchange Calculation

**Table 4–1. The CURRX Menu**

<b>Menu Key</b>	<b>Description</b>
Curr1	Current <i>currency#1</i> ; stores or calculates the number of units of this currency
Curr2	Currency <i>currency#2</i> ; stores or calculates the number of units of this currency
RATE	Stores or calculates the exchange rate between the two current currencies. The rate is expressed as the number of units of <i>currency #2</i> equivalent to 1 unit of <i>currency #1</i> .
C.STO	Stores the current <i>currency #1</i> , <i>currency #2</i> , and RATE.
C.RCL	Recalls a previously stored pair of currencies and RATE.
SELECT	Selects a new set of currencies.

---

## Selecting a Set of Currencies

To select a pair of currencies:

1. Press **SELECT** to display the menu of currencies. Press more, if necessary, to see additional currencies ( see table 4–2 ).
2. Press a menu key to select *currency #1*.
3. Press a menu key to select *currency #2*. RATE is automatically reset to 1.0000.
4. Enter an exchange rate. There are two ways enter the RATE :
  - Calculate the rate from a known equivalency (see the example "Calculating an Exchange Rate," page 57.). Calculating an exchange rate is usually the easier way to enter a correct rate, since the order in which you selected the two currencies doesn't mater.
  - Store the exchange rate by keying in the value and pressing (see "Storing an Exchange Rate" on page 58).

**Table 4–2. Currencies**

<b>US\$</b> United States of America (Dollars)	<b>EUR</b> Austria, Belgium, Germany, Spain, Finland, France, Greece, Ireland, Italy, Luxembourg, Netherlands, Portugal, Vatican City (EURO)	<b>CAN\$</b> Canada (Dollars)	<b>UK£</b> United Kingdom (Pounds)	
<b>SF</b> Switzerland (Francs)	<b>NIS</b> Israeli (New Shekel)	<b>D.KR</b> Denmark (Kroner)	<b>N.KR</b> Norway (Kroner)	<b>S.KR</b> Sweden (Kronor)
<b>R</b> Russia (Rouble) South Africa (Rand) Saudi Arabia (Riyals)	<b>A</b> Argentina	<b>B</b> Vanuatu (Bolvivar)	<b>CZ\$</b> Brazil	<b>INTI</b> Peru
<b>PESO</b> Bolivia Chile, Colombia, Mexico, Philippines, Uruguay (Pesos)	<b>HK\$</b> Hong Kong (Dollars)	<b>NT\$</b> Taiwan (New Dollars)	<b>RMB</b> China (Yuan Renminbi)	<b>WON</b> South Korea (Won)
<b>YEN</b> Japan (Yen)	<b>A\$</b> Australia (Dollars)	<b>M\$</b> Malaysia (Ringgits)	<b>NZ\$</b> New Zealand (Dollars)	<b>RP</b> Indonesia (Rupiahs)
<b>S\$</b> Singapore (Dollars)	<b>BAHT</b> Thailand (Baht)	<b>IN.RS</b> India (Rupee)	<b>PK.RS</b> Pakistani (Rupees)	<b>CURR1</b> <b>CURR2</b> Miscellaneous*
* Use for currencies not shown in table				

## 56 4: Currency Exchange Calculation



---

## Entering a Rate

The following two examples illustrate the two ways to enter an exchange rate.

**Example: Calculating an Exchange Rate.** You have just flown from Canada to United States, and you need to exchange your Canadian Dollars for U.S Dollars. The conversion chart looks this :

United States Conversion Chart (in US\$)	
Currency	Rate
Euro (EUR€)	1.0842
Canadian (CAN\$)	.6584
Hong Kong (HK\$)	.1282

The chart states these equivalencies: \*

1 EUR€ is equivalent to 1.0842 US\$

1 CAN\$ is equivalent to 0.6584 US\$

1 HK\$ is equivalent to 0.1282 US\$

**Part 1:** Select the currencies, and calculate an exchange rate form them.

Keys:	Display:	Description:
<code>CURRX</code>	ENTER A RATE	Display the CURRX menu
<code>SELC</code> <code>CAN\$</code>	SELECT CURRENCY 2	Select CAN\$ as currency #1
<code>US\$</code>	ENTER A RATE	Select US\$ as currency #2
<code>1</code> <code>CAN\$</code>	CAN\$=1.00	Store number of CAN\$

\* The chart is in terms of United States dollars. Many charts have two columns—a “Buy” column and a “Sell” column. The “Buy” column is used for transactions in which the “Bank” buys the listed currency from you in exchange for United States dollars. Thus, if you arrive in United States with CAN\$, the exchange rate in the “Buy” column applies for buying US\$ with your CAN\$. The “Sell” column applies for selling US\$ in exchange for CAN\$.

## 4: Currency Exchange Calculation 57

0.6584	US\$	US\$=0.66	Stores equivalent number of US\$
	RATE	RATE=0.66	Calculates the RATE.

**Part 2:** The following keystrokes show that you can reverse the order in which the two currencies are selected.

Keys:	Display:	Description:
SELECT US\$	SELECT CURRENCY 2	Select US\$ as currency #1
CAN\$	ENTER A RATE	Select CAN\$ as currency #2
1 CAN\$	CAN\$=1.00	Store number of CAN\$
0.6584 US\$	US\$=0.66	Stores equivalent number of US\$
	RATE	Calculates the RATE. (1 ÷ 0.6584)

**Example : Storing an Exchange Rate.** If you choose to store the exchange rate directly, you must select the currencies in the correct order, since the *RATE* is defined as the number of units of *currency #2* equivalent to **one** unit of *currency#1*

Use the United States conversion chart on page 57 to store an exchange rate for converting between Hong Kong Dollars and U.S. Dollars.

Keys:	Display:	Description:
CURRX	ENTER A RATE	Display the CURRX menu
SELECT MORE		Select HK\$ as currency #1
MORE MORE		
HK\$	SELECT CURRENCY 2	
US\$	ENTER A RATE	Select US\$ as currency #2
0.1282 RATE	RATE=0.13	Store the RATE

## 58 4: Currency Exchange Calculation

---

## Converting Between Two Currencies

Once the currencies are selected and a *RATE* has been entered, you can convert any number of units of one currency to the other.

### Example : Converting between Hong Kong and U.S Dollars.

**Part 1:** Use the exchange rate stored in the previous example to calculate how many U.S dollars you would receive for 3,000 Hong Kong Dollars.

Keys:	Display:	Description:
3000 HK\$	HK\$=3,000.00	Store number of HK\$
US\$	US\$=384.60	Calculates equivalent US\$

**Part 2:** A wool sweater in a shop window costs 75 US\$. What is its cost in HK\$ Dollars?

Keys:	Display:	Description:
75 US\$	US\$=75.00	Store number of US\$
HK\$	HK\$=585.02	Calculates equivalent HK\$

---

## Storing and Recalling Sets of Currencies

Pressing **C.STO** or **C.RCL** displays the C.STO/C.RCL menu, which is used to store and recall sets of currencies and the rates. The menu can store up to six sets of currencies. Initially, the menu contains six blank labels.

**Storing Sets of Currencies.** To store the current set of currencies and the rate, press. Then, press **C.STO** any menu key to assign the set to that key. For example, storing the currencies in the previous example stores *currency #1 = HK\$, currency #2 = US\$, and RATE = 0.1282.* ( The values *US\$ = 75* and *HK\$ = 585.02* are not stored.)

**Recalling Sets of Currencies.** To recall a stored set of currencies and their exchange rate, press **C.RCL** , followed by the appropriate menu key. The HP 17bII+ automatically returns to the CURRX menu. The equivalency message and menu labels show the recalled currencies and *RATE*.

---

## Clearing the Currency Variables

Pressing **CLR DATA** while the CURRX menu is displayed sets the *RATE* to 1.0000. The values of the two current currencies are cleared to 0.

## 60 4: Currency Exchange Calculation

# 5

## Time Value of Money

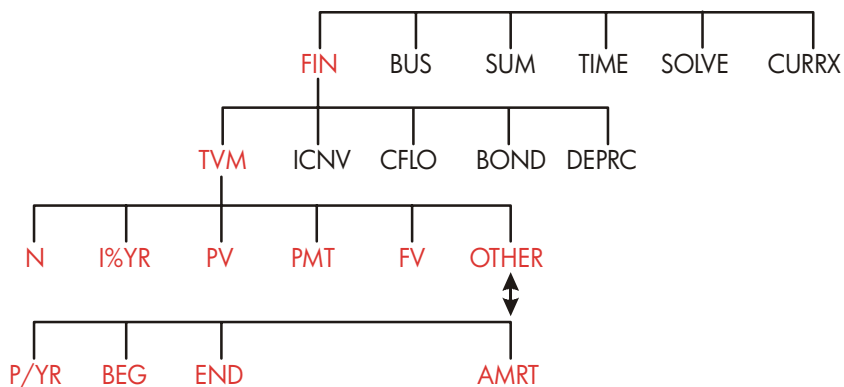
---

The phrase *time value of money* describes calculations based on money earning interest over a period of time. The TVM menu performs compound-interest calculations and calculates (and prints) amortization schedules.

- In *compound interest* calculations, interest is added to the principal at specified *compounding periods*, thereby also earning interest. Savings accounts, mortgages, and leases are compound-interest calculations.
- In *simple interest* calculations, the interest is a percent of the principal and is repaid in one lump sum. Simple interest calculations can be done using the [%] key (page 40). For an example that calculates simple interest using an annual interest rate, see page 190.

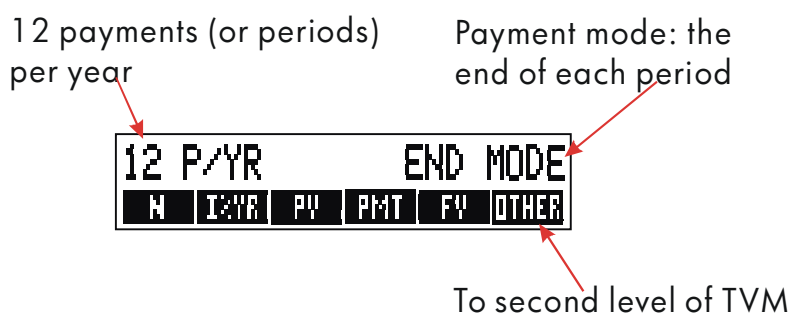
---

### The TVM Menu



The time value of money (TVM) menu does many compound-interest calculations. Specifically, you can use the TVM menu for a series of *cash flows* (money received or money paid) when:

- The dollar amount is the same for each payment.\*
- The payments occur at regular intervals.
- The payment periods coincide with the compounding periods.



**Figure 5-1. The First Level of TVM**


The first level of the TVM menu has five menu labels for variables plus **OTHER**. The **OTHER** key accesses a second-level menu used to specify payment conditions (the *payment mode*) and to call up the AMRT (*amortization*) menu.



**Figure 5-2. The Second Level of TVM**



\* For situations where the amount of the payment varies, use the CFLO (*cash flows*) menu.



**Table 5-1. TVM Menu Labels**


Menu Label	Description
<b>First Level</b>	
N	Stores (or calculates) the <i>total</i> number of payments or compounding periods.* † (For a 30-year loan with monthly payments, $N = 12 \times 30 = 360$ .)
☐ N	Shortcut for N: Multiplies the number in the display by <i>P/YR</i> , and stores the result in <i>N</i> . (If <i>P/YR</i> were 12, then 30 ☐ N would set $N = 360$ .)
I%YR	Stores (or calculates) the nominal <i>annual</i> interest rate as a percentage.
PV	Stores (or calculates) the present value—an initial cash flow or a discounted value of a series of future cash flows ( <i>PMTs</i> + <i>FV</i> ). To a lender or borrower, <i>PV</i> is the amount of the loan; to an investor, <i>PV</i> is the initial investment. If <i>PV</i> paid out, it is negative. <i>PV</i> always occurs at the beginning of the first period.
PMT	Stores (or calculates) the dollar amount of each periodic payment. All payments are equal, and no payments are skipped. (If the payments are unequal, use CFLO, not TVM.) Payments can occur at the beginning or end of each period. If <i>PMT</i> represents money paid out, it is negative.
FV	Stores (or calculates) the future value—a final cash flow or a compounded value of a series of previous cash flows ( <i>PV</i> + <i>PMTs</i> ). <i>FV</i> always occurs at the end of the last period. If <i>FV</i> is paid out, it is <i>negative</i> .
	
<b>Second Level</b>	
P/YR	Specifies the number of payments or compounding periods per year. † (it must be an integer, 1 through 999.)
<p>* When a non-integer <i>N</i> (an “odd period”) is calculated, the answer must be interpreted carefully. See the savings account example on page 71. Calculations using a stored, non-integer <i>N</i> produce a mathematically correct result, but this result has no simple interpretation. The example on page 172 uses the Solver to do a partial-period (non-integer) calculation in which interest begins to accrue prior to the beginning of the first regular payment period.</p> <p>† The number of payment periods must equal the number of compounding periods. If this is not true, see page 87. For Canadian mortgages, see page 197.</p>	

**Table 5-1. TVM Menu Labels (Continued)**

Menu Label	Description
<b>Second Level (Continued)</b>	
BEG	Sets <i>Begin mode</i> : payments occur at the beginning of each period. Typical for savings plans and leasing. (The Begin and End modes do not matter if $PMT=0$ .)
END	Sets <i>End mode</i> : payments occur at the end of each period. Typical for loans and investments.
PMT	Accesses the <i>amortization</i> menu. See page 78.

The calculator retains the values of the TVM variables until you clear them by pressing . When you see the first-level TVM menu, pressing  clears  $N$ ,  $I\%YR$ ,  $PV$ ,  $PMT$ , and  $FV$ .

When the second-level menu (  ) is displayed, pressing  resets the payment conditions to  $12 P/YR$   $END$   $MODE$ .

To see what value is currently stored in a variable, press  *menu label*. This shows you the value without recalculating it.

---

## Cash Flow Diagrams and Signs of Numbers

It is helpful to illustrate TVM calculations with *cash-flow diagrams*. Cash-flow diagrams are time lines divided into equal segments called *compounding* (or *payment*) *periods*. Arrows show the occurrence of cash flows (payments in or out). Money received is a positive number (arrow up) and money paid out is a negative number (arrow down).



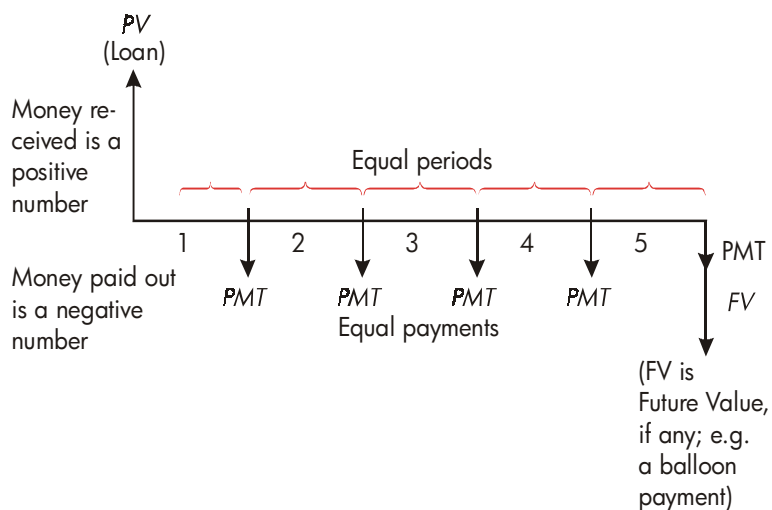
**Note**

The correct *sign* (positive or negative) for TVM numbers is essential. The calculations will make sense only if you consistently show *payments out* as *negative* and *payments in*

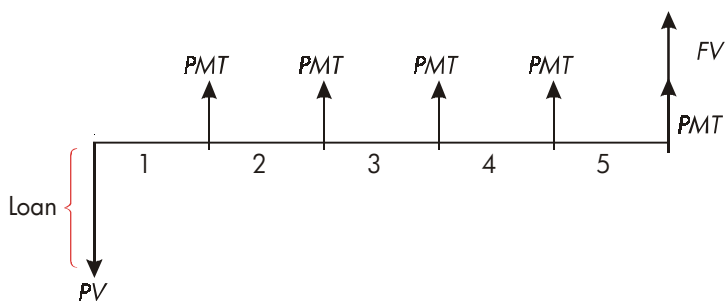
## 64 5: Time Value of Money



(receipts) as *positive*. Perform a calculation from the point of view of *either* the lender (investor) or the borrower, but not both!

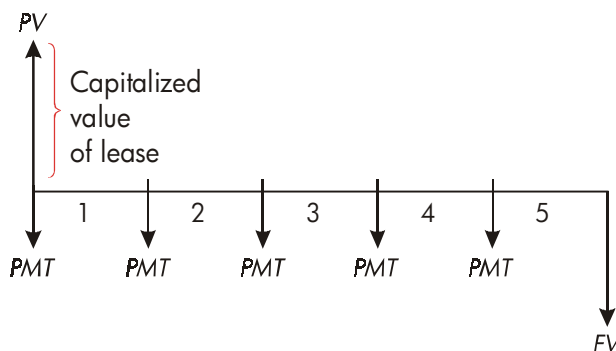


**Figure 5-3. A Cash Flow Diagram for a Loan from Borrower's Point of View (End Mode)**



**Figure 5-4. A Cash Flow Diagram for a Loan from Lender's Point of View (End Mode)**

Payments occur at either the *beginning* of each period or the *end* of each period. End mode is shown in the last two figures; Begin mode is shown in the next figure.



**Figure 5-5. Lease Payments Made at the Beginning of Each Period (Begin Mode)**

---

## Using the TVM Menu



First draw a cash-flow diagram to match your problem. Then:

1. From the MAIN menu, press **FIN** **TVM**.
2. To clear previous TVM values, press **CLR DATA**, (Note: You don't need to clear data if you enter new values for *all five* variables, or if you *want* to retain previous values.)
3. Read the message that describes the number of payments per year and the payment mode (Begin, End). If you need to change either of these settings, press **OTHER**.
  - To change the number of payments per year, key in the new value and press **P/YR**. (If the number of payments is different from the number of compounding periods, see "Compounding Periods Different from Payment Periods," page 87.)
  - To change the Begin/End mode, press **BEG** or **END**.
  - Press **EXIT** to return to the primary TVM menu.

## 66 5: Time Value of Money

4. Store the values you know. (Enter each number and press its menu key.)
5. To calculate a value, press the appropriate menu key.

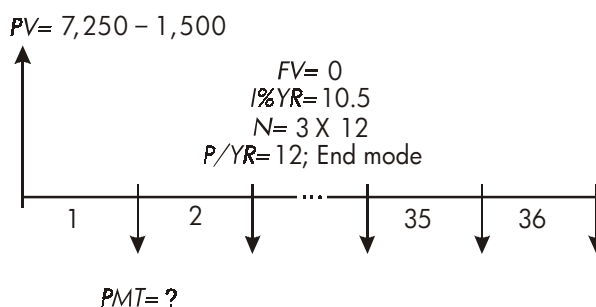
You must give every variable—except the one you will calculate—a value, even if that value is zero. For example, *FV* must be set to zero when you are calculating the periodic payment (*PMT*) required to fully pay back a loan. There are two ways to set values to zero:

- Before storing any TVM values, press  to clear the previous TVM values.
- Store zero; for example, pressing 0  sets *FV* to zero.

## Loan Calculations

Three examples illustrate common loan calculations. (For amortization of loan payments, see page 77.) Loan calculations typically use End mode for payments.

**Example:A Car Loan.** You are financing the purchase of a new car with a 3-year loan at 10.5% annual interest, compounded monthly. The purchase price of the car is \$7,250. Your down payment is \$1,500. What are your monthly payments? (Assume payments start one month after purchase — in other words, at the end of the first period.) What interest rate would reduce your monthly payment by \$10?



**Keys:**

FIN TVM

CLR DATA

OTHER

CLR DATA

EXIT

✓ 3 × 12

N

10.5 I%YR

✓ 7250 = 1500

PV

PMT

**Display:**

12 P/YR END MODE

12 P/YR END MODE

N=36.00

I%YR=10.50

PV=5,750.00

PMT=-186.89

**Description:**

Displays TVM menu.

Clears history stack and TVM variables.

If needed: sets 12 payment periods per year; End mode.

Figures and stores number of payments.

Stores annual interest rate.

Stores amount of the loan.

Calculates payment.

Negative value means money to be *paid out*.

To calculate the interest rate that reduces the payment by \$10, *add* 10 to reduce the negative *PMT* value.

✓ + 10 PMT PMT=-176.89

I%YR

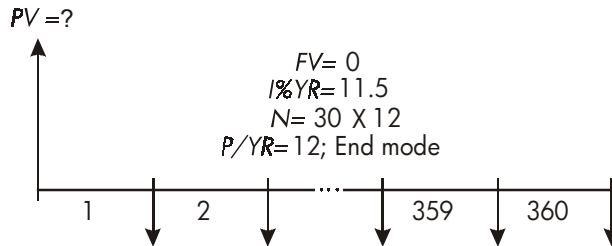
I%YR=6.75

Stores the reduced payment amount.

Calculates the annual interest rate.

**Example: A Home Mortgage.** After careful consideration of your personal finances, you've decided that the maximum monthly mortgage payment you can afford is \$630. You can make a \$12,000 down payment, and annual interest rates are currently 11.5%. If you take out a 30-year mortgage, what is the maximum purchase price you can afford?

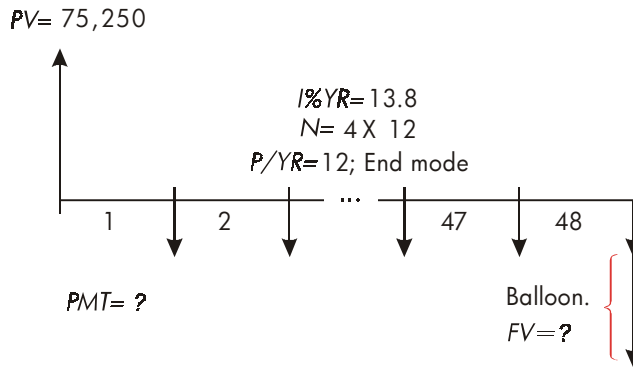
**68 5: Time Value of Money**



PMT=-630

Keys:	Display:	Description:
FIN TVM		Display TVM menu.
<input type="checkbox"/> CLR DATA	12 P/YR END MODE	Clears history stack and TVM variables.
OTHER <input type="checkbox"/> CLR DATA		If needed: sets 12 payment periods per year; End mode.
EXIT	12 P/YR END MODE	
30 <input type="checkbox"/> N	H=360.00	Pressing <input type="checkbox"/> first multiplies 30 by 12, then stores this number of payments in N.
11.5 I%YR	I%YR=11.50	Stores annual interest rate.
630 +/-		Stores a <i>negative</i> monthly payment.
PMT	PMT=-630.00	
PV	PV=63,617.64	Calculates loan amount.
<input checked="" type="checkbox"/> 12000 <input type="checkbox"/>	75,617.64	Calculates total price of the house (loan plus down payment).

**Example: A Mortgage with a Balloon Payment.** You've taken out a 25-year, \$75,250 mortgage at 13.8% annual interest. You anticipate that you will own the house for four years and then sell it, repaying the loan in a "balloon payment." What will be the size of your balloon payment?



The problem is done in two steps:

1. Calculate the monthly payment without the balloon ( $FV=0$ ).
2. Calculate the balloon payment after 4 years.

**Keys:**

FIN TVM

CLR DATA

OTHER  CLR DATA

EXIT

**Display:**

12 P/YR END MODE

12 P/YR END MODE

**Description:**

Display TVM menu.

Clears history stack and TVM variables.

If needed: sets 12 payment periods per year; End mode.

**Step 1.** Calculate *PMT* for the mortgage.

25  N

N=300.00

Figures and stores the number of monthly payments in 25 years.

13.8 I%YR

I%YR=13.80

Stores annual interest rate.

75250 PV

PV=75,250.00

Stores amount of the loan.

PMT

PMT=-894.33

Calculates monthly payment.

**70 5: Time Value of Money**

**Step 2.** Calculate the balloon payment after 4 years.

894.33

PMT

PMT=-894.33

Stores *rounded* PMT value for exact payment amount (no fractional cents).\*

4

N

N=48.00

Figures and stores number of payments in 4 years.

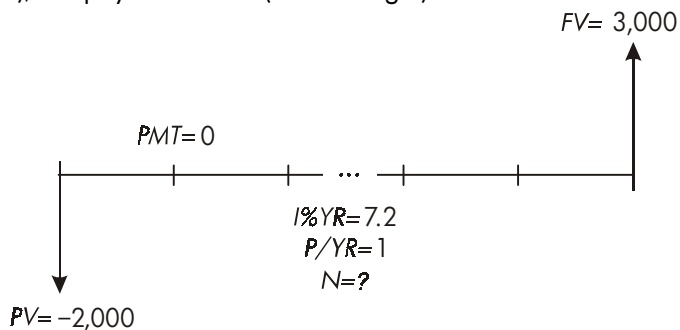
FV

PV=-73,408.81

Calculates balloon payment after four years. This amount plus last monthly payment repays the loan.

## Savings Calculations

**Example: A Savings Account.** You deposit \$2,000 into a savings account that pays 7.2% annual interest, compounded annually. If you make no other deposits into the account, how long will it take for the account to grow to \$3,000? Since this account has no regular payments ( $PMT=0$ ), the payment mode (End or Begin) is irrelevant.



\* The PMT stored in the previous step is the 12-digit number -894.330557971. The calculation of the balloon payment must use the actual monthly payment amount: the rounded number \$894.33, an exact dollars-and-cents amount.

**Keys:**

FIN

TVM

CLR DATA

OTHER

1 P/YR

EXIT

7.2 I%YR

2000 +/- PV

3000 FV

N

**Display:**

12 P/YR END MODE

1 P/YR END MODE

I%YR=7.20

PV=-2,000.00

FV=3,000.00

N=5.83

**Description:**

Displays TVM menu.

Clears history stack and TVM variables.

Sets one compounding per./yr. (one interest pmt./yr.). Payment mode does not matter.

Stores annual interest rate.

Stores amount of deposit.

Stores future account balance in *FV*.

Calculates number of compounding periods (years) for the account to reach \$3,000.

There is no conventional way to interpret results based on a non-integer value (5.83) of *N*. Since the calculated value of *N* is between 5 and 6, it will take 6 years of annual compounding to achieve a balance of at least \$3,000. The actual balance at the end of 6 years can be calculated as follows:

6 N

N=6.00

Stores a whole number of years in *N*.

FV

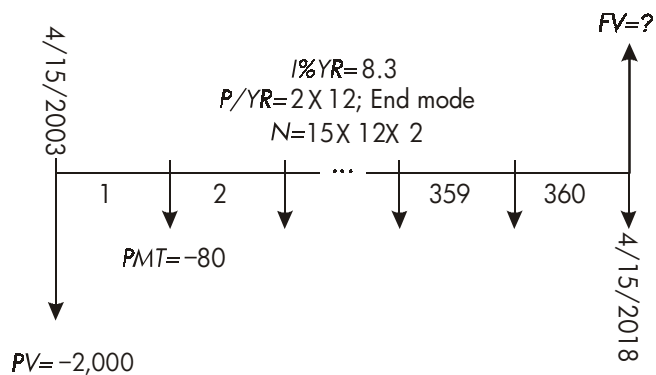
FV=3,035.28

Calculates account balance after six years.

**Example: An Individual Retirement Account (IRA).** You opened an IRA on April 15, 2003, with a deposit of \$2,000. Thereafter, you deposit \$80.00 into the account at the end of each half-month. The account pays 8.3% annual interest, compounded semimonthly. How much money will the account contain on April 15, 2018?

**72 5: Time Value of Money**





### Keys:

FIN TVM

OTHER

24 P/YR

END EXIT

15  N

8.3 I%YR

2000  PV

80  PMT

FV

### Display:

24 P/YR END MODE

N=360.00

I%YR=8.30

PV=-2,000.00

PMT=-80.00

FV=63,963.84

### Description:

Displays TVM menu. It is not necessary to clear data because you do not need to set any of the values to zero.

Sets 24 payment periods per year. End mode.

Figures and stores number of deposits in  $N$ .

Stores annual interest rate.

Stores initial deposit.

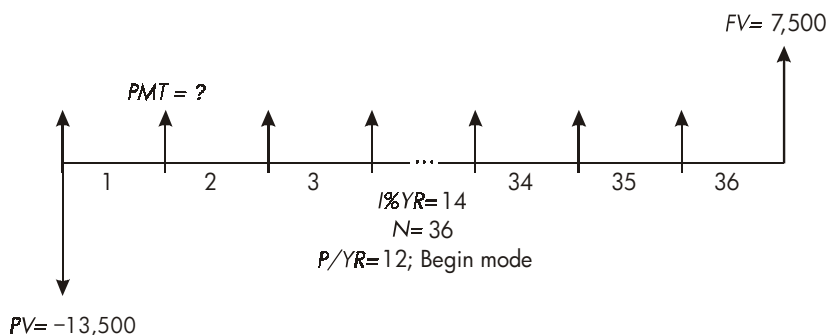
Stores semimonthly payment.

Calculates balance in IRA after 15 years.

## Leasing Calculations

Two common leasing calculations are 1) finding the lease payment necessary to achieve a specified yield, and 2) finding the present value (capitalized value) of a lease. Leasing calculations typically use "advance payments". For the calculator, this means Begin mode because all payments will be made at the beginning of the period. If there are two payments in advance, then one payment must be combined with the present value. For examples with two or more advance payments, see pages 75 and 199.

**Example: Calculating a Lease Payment.** A new car valued at \$13,500 is to be leased for 3 years. The lessee has the option to purchase the car for \$7,500 at the end of the leasing period. What monthly payments, with one payment in advance, are necessary to yield the lessor 14% annually? Calculate the payments from the lessor's point of view. Use Begin payment mode because the first payment is due at the inception of the lease.



### Keys:

FIN TVM

OTHER

12 P/YR

BEG (EXIT)

36 N

### Display:

12 P/YR BEGIN  
MODE

N=36.00

### Description:

Displays TVM menu.

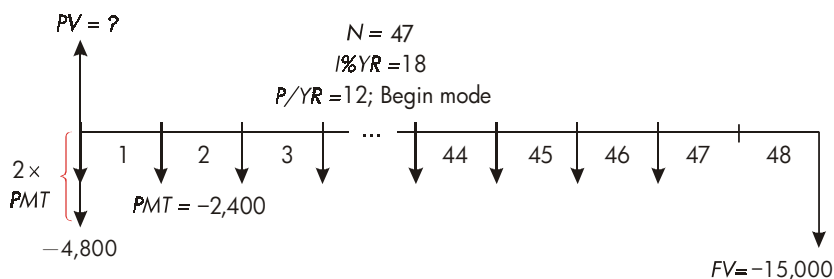
Sets 12 payment periods  
per year, Begin mode.

Stores number of payments.

## 74 5: Time Value of Money

14	I%YR	I%YR=14.00	Stores annual interest rate.
13500	$\boxed{+/-}$		Stores car's value in PV.
	PV	PV=-13,500.00	(Money paid out by lessor.)
7500	FV	FV=7,500.00	Stores purchase option value in FV. (Money received by lessor.)
	PMT	PMT=289.19	Calculates monthly payment received.

**Example: Present Value of a Lease with Advance Payments and Option to Buy.** Your company is leasing a machine for 4 years. Monthly payments are \$2,400 with two payments in advance. You have an option to buy the machine for \$15,000 at the end of the leasing period. What is the capitalized value of the lease? The interest rate you pay to borrow funds is 18%, compounded monthly.



The problem is done in four steps:

1. Calculate the present value of 47 monthly payments in Begin mode. (Begin mode makes the first payment an advance payment.)
2. Add one additional payment to the calculated present value. This adds a second advance payment to the beginning of the leasing period, replacing what would have been the final (48th) payment.
3. Find the present value of the buy option.
4. Add the present values calculated in steps 2 and 3.

**Keys:**

FIN TVM

CLR DATA

OTHER

12 P/YR

BEG EXIT

**Display:**

12 P/YR END MODE

12 P/YR BEGIN  
MODE**Description:**

Displays TVM menu.

Clears history stack and  
TVM variables.Sets 12 payment periods  
per year; Begin mode.**Step 1:** Find the present value of the monthly payments.

47 N

N=47.00

Stores number of payments.

18 I/YR

I/YR=18.00

Stores annual interest rate.

2400 +/-

PMT

PMT=-2,400.00

Stores monthly payment.

PV

PV=81,735.58

Calculates present  
(capitalized) value of the  
47 monthly payments.**Step 2:** Add the additional advance payment to PV. Store the answer.

✓ (+) 2400 (=)

84,135.58

Calculates present value of  
all payments.

STO 0

84,135.58

Stores result in register 0.

**Step 3:** Find the present value of the buy option.

48 N

N=48.00

Stores number of payment  
periods.

15000 +/-

FV

FV=-15,000.00

Stores amount of the buy  
option (money paid out).

0 PMT

PMT=0.00

There are no payments.

**76 5: Time Value of Money**

PV

PV=7,340.43

Calculates present value of the buy option.

**Step 4:** Add the results of step 2 and 3.

✓ (+) (RCL) 0 (=)

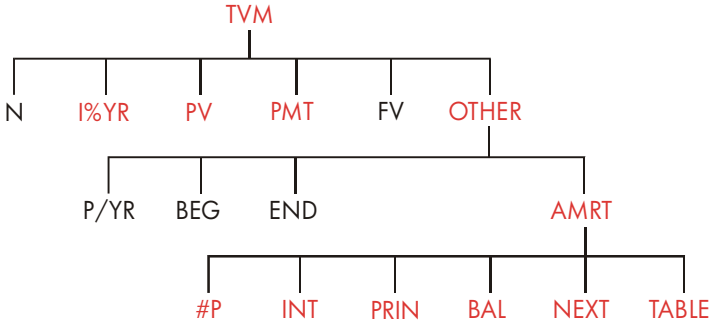
91,476.00

Calculates present, capitalized value of lease.

### Amortization (AMRT)

The AMRT menu (press TVM OTHER AMRT ) displays or prints the following values:

- The loan balance after the payment(s) are made.
- The amount of the payment(s) applied toward interest.
- The amount of the payment(s) applied toward principal.



**Table 5-2. AMRT Menu Labels**

<b>Menu Label</b>	<b>Description</b>
#P	Stores the number of payments to be amortized, and calculates an amortization schedule for that many payments. Successive schedules start where the last schedule left off. #P can be an integer from 1 through 1,200.
INT	Displays the amount of the payments applied toward interest.
PRIN	Displays the amount of the payments applied toward principal.
BAL	Displays the balance of the loan.
NEXT	Calculates the next amortization schedule, which contains #P payments. The next set of payments starts where the previous set left off.
TABLE	Displays a menu for printing an amortization table (schedule).

## Displaying an Amortization Schedule

For amortization calculations, you need to know *PV*, *I%YR*, and *PMT*. If you have just finished doing these calculations with the TVM menu, then skip to step 3.

### To calculate and display an amortization schedule:\*

1. Press **FIN** **TVM** to display the TVM menu.

\* Amortization calculations use values of *PV*, *PMT*, and *INT* rounded to the number of decimal places specified by the current display setting. A setting of **FIX** 2 means that these calculations will be rounded to two decimal places.

## 78 5: Time Value of Money

2. Store the values for  $I\%YR$ ,  $PV$ , and  $PMT$ . (Press  $\pm/\mp$  to make  $PMT$  a negative number.) If you need to calculate one of these values, follow the instructions under "Using the TVM Menu," on page 66. Then go on to step 3.
3. Press **OTHER** to display the rest of the TVM menu.
4. If necessary, change the number of payment periods per year stored in **P/YR**.
5. If necessary, change the payment mode by pressing **BEG** or **END**. (Most loan calculations use End mode.)
6. Press **AMRT**. (If you want to *print* the amortization schedule, go to page 82 to continue.)
7. Key in the number of payments to be amortized at one time and press **#P**. For example, to see a year of monthly payments at one time, set  $\#P$  to 12. To amortize the entire life of a loan at one time, set  $\#P$  equal to the total number of payments ( $N$ ).  
If  $\#P = 12$ , the display would show:

Number of payments  
amortized at one time

Current set of  
payments to be amortized

#P=12 PMTS: 1-12

#P	INT	PRIN	BAL	NEXT	TABLE
----	-----	------	-----	------	-------

Press to see results

8. To display the results, press, **INT**, **PRIN** and **BAL** (or press  $\nabla$  to view the results from the stack).
9. To continue calculating the schedule for *subsequent* payments, do **a** or **b**. To start the schedule over, do **c**.
  - a.** To calculate the next *successive* amortization schedule, with the same number of payments, press **NEXT**.

Next successive set of payments authorized

#P=12 PMTS: 13-24  
 #P INT PRIN BAL NEXT TABLE

- b. To calculate a subsequent schedule with a *different* number of payments, key in that number and press **#P**.
- c. To start over from payment #1 (using the same loan information), press **CLR DATA** and proceed from step 7.

**Example: Displaying an Amortization Schedule.** To purchase your new home, you have taken out a 30-year, \$65,000 mortgage at 12.5% annual interest. Your monthly payment is \$693.72. Calculate the amount of the first year's and second year's payments that are applied toward principal and interest.

Then calculate the loan balance after 42 payments (3½ years).

Keys:	Display:	Description:
<b>FIN</b> <b>TVM</b>		Displays TVM menu.
12.5 <b>I%YR</b>	I%YR=12.50	Stores annual interest rate.
65000 <b>PV</b>	PV=65,000.00	Stores loan amount.
693.72 <b>+/-</b>		Stores monthly payment.
<b>PMT</b>	PMT=-693.72	
<b>OTHER</b>		If needed: sets 12
<b>CLR DATA</b>	12 P/YR END MODE	payment periods per year; End mode.
<b>AMRT</b>	KEY #PMTS; PRESS {#P}	Displays AMRT menu.
12 <b>#P</b>	#P=12 PMTS: 1-12	Calculates amortization schedule for first 12

## 80 5: Time Value of Money



		payments, but does not display it.
INT	INTEREST=-8,113.16	Displays interest paid in first year.
PRIN	PRINCIPAL=-211.48	Displays principal paid in first year.
BAL	BALANCE=64,788.52	Displays balance at end of first year.
NEXT	#P=12 PMTS: 13-24	Calculates amortization schedule for next 12 payments.
INT	INTEREST=-8,085.15	Displays results for second year.
PRIN	PRINCIPAL=-239.49	
BAL	BALANCE=64,549.03	

To calculate the balance after 42 payments (3½ years), amortize 18 additional payments (42 - 24 = 18):

18	#P	#P=18 PMTS: 25-42	Calculates amortization schedule for next 18 months.
INT		INTEREST= -12,066.98	Displays results.
PRIN		PRINCIPAL=-419.98	
BAL		BALANCE=64,129.05	

### Printing an Amortization Table (TABLE)

To print an amortization schedule (or "table") do steps 1 through 5 for displaying an amortization schedule (see page 78).

6. Press **AMRT** Ignore the message **KEY #PMTS ; PRESS (<#P>)**.
7. Press **TABLE**.
8. Key in the payment number of the first payment in the schedule and press **FIRST**. (For instance, for the very first payment, *FIRST*= 1.)
9. Key in the payment number of the last payment in the schedule and press **LAST**.
10. Key in the increment — the number of payments shown at one time— and press **INCR**. (For instance, for one year of monthly payments at a time, *INCR*=12.)
11. Press **GO**.

Values are retained until you exit the TABLE menu, so you can print successive amortization schedules by re-entering only those TABLE values that change.

**Example: Printing an Amortization Schedule.** For the loan described in the previous example (page 80), print an amortization table with entries for the fifth and sixth years. You can continue from the AMRT menu in the previous example (step 7, above) or repeat steps 1 through 6.

Starting from the AMRT menu:

<b>Keys:</b>	<b>Display:</b>	<b>Description:</b>
<b>TABLE</b>	PRINT AMORT TABLE	Displays menu for printing amortization table.
✓ 4 <input type="text" value="x"/> 12 <input type="text" value="+"/> 1 <b>FIRST</b>	FIRST=49.00	The 49th is the first payment in year 5.
✓ 6 <input type="text" value="x"/> 12 <b>LAST</b>	LAST=72.00	The 72nd is the last payment in year 6.
12 <b>INCR</b>	INCR=12.00	Each table entry represents 12 payments

## 82 5: Time Value of Money

GO

(1 year).  
Calculates and prints  
amortization schedule  
shown below.

```
I%YR=      12.50
PV=        65,000.00
PMT=       -693.72
FV=         0.00
P/YR=      12.00
END MODE

PMTS:49-60
INTEREST=  -7,976.87
PRINCIPAL= -347.77
BALANCE=   63,622.94

PMTS:61-72
INTEREST=  -7,930.82
PRINCIPAL= -393.82
BALANCE=   63,229.12
```

# 6

## Interest Rate Conversions

---

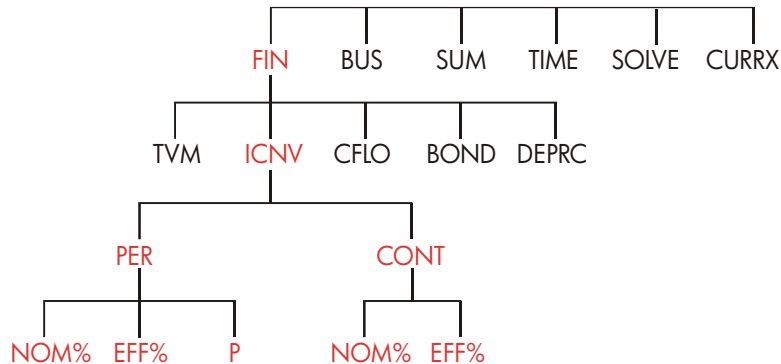
The interest conversion (ICNV) menu converts between nominal and effective interest rates. To compare investments with different compounding periods, their *nominal interest rates* are converted to *effective interest rates*. This allows you, for example, to compare a savings account that pays interest quarterly with a bond that pays interest semiannually.

- The nominal rate is the stated annual interest rate compounded *periodically*, such as 18% per year compounded monthly.
- The effective rate is the rate that, *compounded only once* (that is, annually), would produce the same final value as the nominal rate. A nominal annual rate of 18% compounded monthly equals an effective annual rate of 19.56%.

When the compounding period for a given nominal rate is one year, then that nominal annual rate *is the same* as its effective annual rate.

---

## The ICNV Menu



The ICNV menu converts between nominal and effective interest rates, using either:

- Periodic compounding; for example, quarterly, monthly, or daily compounding.
- Continuous compounding.

---

## Converting Interest Rates

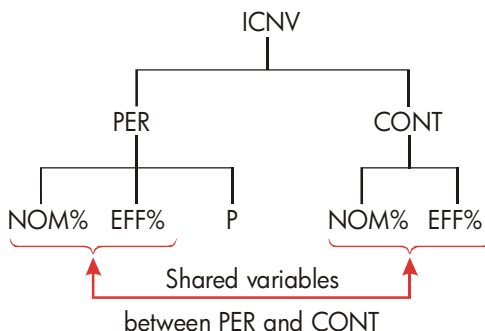
**To convert between a nominal annual interest rate and an effective annual interest rate that is compounded *periodically*:**

1. Press **FIN** **ICNV** to display the interest conversions menu.
2. Press **PER** for *periodic*.
3. Key in the number of compounding periods per year and press **P**.
4. To convert to the effective rate, first key in the nominal rate and press **NOM%**, then press **EFF%**.
5. To convert to the nominal rate, first key in the effective rate and press **EFF%**, then press **NOM%**.

**To convert between a nominal annual interest rate and an effective annual interest rate that is compounded *continuously*:**

1. Press **FIN** **ICNV** to get the interest conversions menu.
2. Press **CONT** for “continuous”.
3. To convert to the effective rate, key in the nominal rate and press **NOM%**, then press **EFF%**.
4. To convert to the nominal rate, key in the effective rate and press **EFF%**, then press **NOM%**.

Values of *EFF%* and *NOM%* are shared between the PER and CONT menus. For example, an effective interest rate in CONT remains stored in *EFF%* when you exit the CONT menu and enter the PER menu. Pressing **CLR DATA** in either menu clears *NOM%* and *EFF%* in both.



**Example: Converting from a Nominal to an Effective Interest Rate.**

You are considering opening a savings account in one of three banks. Which bank has the most favorable interest rate?

- Bank #1 6.7% annual interest, compounded quarterly.
- Bank #2 6.65% annual interest, compounded monthly.
- Bank #3 6.65% annual interest, compounded continuously.

**Keys:**

**FIN** **ICNV**  
**PER**

**Display:**

COMPOUNDING P  
TIMES/YR

**Description:**

Displays ICNV menu.  
Displays PER menu.

4	P	P=4.00	Stores number of compounding periods per year for bank #1.
6.7	NOM%	NOM%=6.70	Stores nominal annual interest rate for bank #1.
	EFF%	EFF%=6.87	Calculates effective interest rate for bank #1.
12	P	P=12.00	Stores number of compounding periods per year for bank #2.
6.65	NOM%	NOM%=6.65	Stores nominal annual interest rate for bank #2.
	EFF%	EFF%=6.86	Calculates effective interest rate for bank #2.
EXIT	CONT	CONTINUOUS COMPOUNDING	Displays CONT menu. Previous values of NOM% and EFF% are retained.
	EFF%	EFF%=6.88	Calculates effective rate for bank #3.

The calculations show that bank #3 is offering the most favorable interest rate.

---

## Compounding Periods Different from Payment Periods

The TVM menu assumes that the compounding periods and the payment periods are the same. However, regularly occurring savings- account deposits and withdrawals do not necessarily occur at the same time as the bank's compounding periods. If they are not the same, you can adjust the interest rate using the ICNV menu, and then use the adjusted

interest rate in the TVM menu. (You can also use TVM if  $PMT = 0$ , regardless of the compounding periods.)

1. Call up the periodic interest-rate conversion menu ( **FIN** **ICNV** **PER** ).
2. Calculate the effective annual interest rate from the nominal annual interest rate given by the bank.
  - a. Store annual interest rate in **NOM%** .
  - b. Store number of compounding periods per year in **P** .
  - c. Press **EFF%** .
3. Calculate the nominal annual interest rate that corresponds to your payment periods.
  - a. Store the number of regular payments or withdrawals you will be making per year in **P** .
  - b. Press **NOM%** .
4. Return to the TVM menu ( **EXIT** **EXIT** **TVM** ).
5. Store the just-calculated nominal interest rate in **I%YR** (press **STO** **I%YR** ).
6. Store the number of payments or withdrawals per year in **P/YR** and set the appropriate payment mode.
7. Continue with the TVM calculation. (Remember that money paid out is negative; money received is positive.)
  - a.  $N$  is the total number of periodic deposits or withdrawals.
  - b.  $PV$  is the initial deposit.
  - c.  $PMT$  is the amount of the regular, periodic deposit or withdrawal.
  - d.  $FV$  is the future value.

When the interest rate is the unknown variable, first calculate **I%YR** in the TVM menu. This is the nominal annual rate that corresponds to your payment periods. Next, use the **ICNV** menu to convert this to the

## 88 6: Interest Rate Conversions





effective interest rate based on your payment periods. Last, convert the effective rate to the nominal rate based on the bank's compounding periods.

**Example: Balance of a Savings Account.** Starting today, you make monthly deposits of \$25 into an account paying 5% interest compounded daily (365-day basis). At the end of 7 years, how much will you receive from the account?

<b>Keys:</b>	<b>Display:</b>	<b>Description:</b>
FIN ICNV	SELECT	
	COMPOUNDING	
PER	COMPOUNDING P	Periodic interest-rate
	TIMES/YR	conversion menu.
365 P	P=365.00	Stores bank's
		compounding periods.
5 NOM%	NOM%=5.00	Stores bank's nominal
		interest rate.
EFF%	EFF%=5.13	Calculates effective interest
		rate for daily compounding.
12 P	P=12.00	Stores number of deposits
		per year.
NOM%	NOM%=5.01	Calculates equivalent
		nominal interest rate for
		monthly compounding.
EXIT EXIT		Switches to TVM menu;
TVM ←	5.01	NOM% value is still in
		calculator line.
STO I%YR	I%YR=5.01	Stores adjusted nominal
		interest rate in I%YR.
OTHER 12 P/YR		Sets 12 payments per
BEG EXIT	12 P/YR BEGIN MODE	year; Begin mode.

## 6: Interest Rate Conversions 89

7  N  
 25  PMT  
 0 PV PV=0.00  
 FV FV=2,519.61

Stores 84 deposit periods,  
 \$25 per deposit, and no  
 money before the first  
 regular deposit.  
 Value of account in 7  
 years.

If the interest rate were the unknown, you would first do the TVM calculation to get *I%YR* (5.01). Then, in the ICNV PER menu, store 5.01 as *NOM%* and 12 as *P* for monthly compounding. Calculate *EFF%* (5.13). Then change *P* to 365 for daily compounding and calculate *NOM%* (5.00). This is the bank's rate.

## 90 6: Interest Rate Conversions

# 7

## Cash Flow Calculations

---

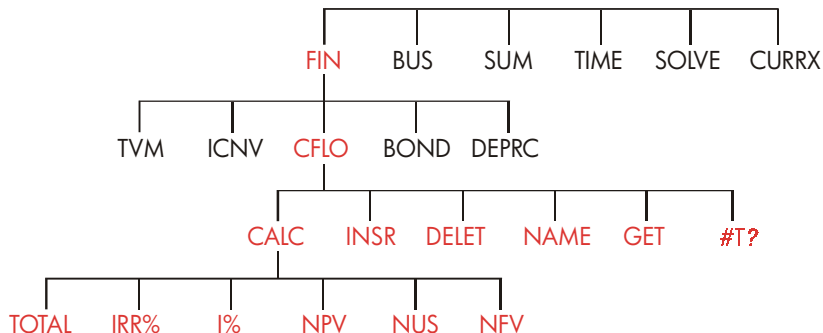
The cash flow (CFLO) menu stores and analyzes cash flows (money received or paid out) of *unequal (ungrouped)* amounts that occur at regular intervals.\* Once you've entered the cash flows into a *list*, you can calculate:

- The total amount of the cash flows.
- The internal rate of return (IRR%).
- The net present value (NPV), net uniform series (NUS), and net future value (NFV) for a specified periodic interest rate (I%).

You can store many separate lists of cash flows. The maximum number depends on the amount of available calculator memory.

---

### The CFLO menu



The CFLO menu creates cash-flow lists and performs calculations with a list of cash flows.

\* You can also use CFLO with cash flows of *equal* amounts, but these are usually handled more easily by the TVM menu.

**Table 7-1. CFLO Menu Labels**

<b>Menu Label</b>	<b>Description</b>
<b>CALC</b>	Accesses the CALC menu to calculate <i>TOTAL</i> , <i>IRR%</i> , <i>NPV</i> , <i>NUS</i> , <i>NFV</i> .
<b>INSR</b>	Allows you to insert cash flows into a list.
<b>DELET</b>	Deletes cash flows from a list.
<b>NAME</b>	Allows you to name a list.
<b>GET</b>	Allows you to switch from one list to another or create a new list.
<b>#T?</b>	Turns the prompting for <i>#TIMES</i> on and off.

To see the calculator line when this menu is in the display, press **INPUT** once. (This does not affect number entry.)

To see this menu when the calculator line is in the display, press **EXIT**.

---

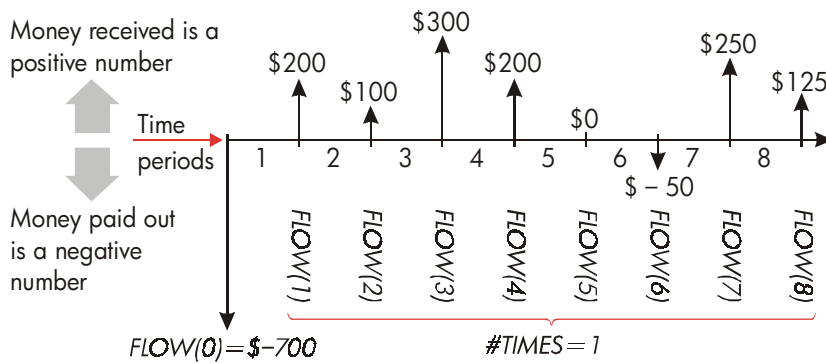
## **Cash Flow Diagrams and Signs of Numbers**

The sign conventions used for cash flow calculations are the same as those used in time-value-of-money calculations. A typical series of cash flows is one of two types:

- *Ungrouped cash flows*. These occur in series of cash flows *without* "groups" of equal, consecutive flows. \* Because each flow is different from the one before it, the *number of times* each flow occurs is one.

\* Any cash flow series can be treated as an ungrouped one if you enter each flow individually.

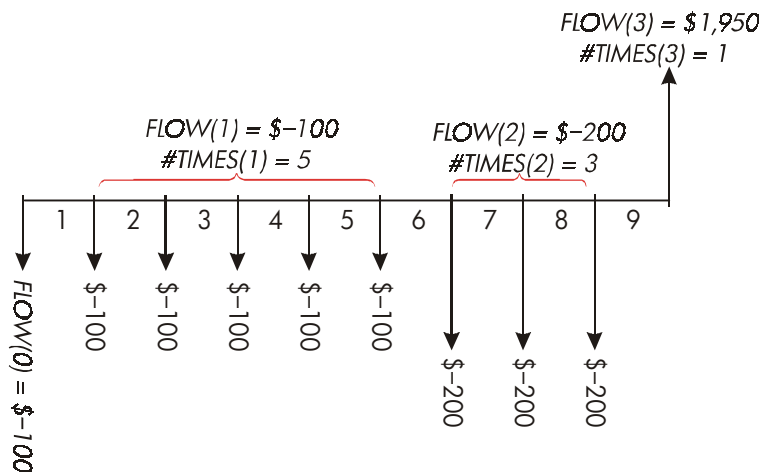
## **92 7: Cash Flow Calculations**



**Figure 7-1. Cash Flows (Ungrouped)**

The horizontal timeline is divided into equal compounding periods. The vertical lines represent the cash flows. For money received, the line points up (positive); for money paid out, the line points down (negative). In this case, the investor has invested \$700. This investment has generated a series of cash flows, starting at the end of the first period. Notice that there is no cash flow (a cash flow of zero) for period five, and that the investor pays a small amount in period six.

- *Grouped cash flows.* These occur in a series containing “groups” of equal, consecutive flows. Consecutive, equal cash flows are called *grouped cash flows*. The series shown here is grouped into two sets of consecutive, equal cash flows:



**Figure 7-2. Grouped Cash Flows**

After an initial payment of \$100, the investor pays \$100 at the end of periods 1 through 5, and \$200 at the end of periods 6 through 8. The investment returns \$1,950 at the end of period 9. For every cash flow you enter, the calculator prompts you to indicate how many times (*#TIMES*) it occurs.

---

## Creating a Cash-Flow List

To use CFLO, be sure your cash flows are occurring at regular intervals and at the *end* of each period.\* If a period is skipped, enter zero for its cash flow. If there are any *grouped* (consecutive and equal) cash flows, the *#TIMES* prompting makes entering the data easier.

\* If the cash flows occur at the beginning of each period, then combine the first flow with the initial flow (which can increase or decrease the flow), and move each cash flow up one period. (Remember: a payment made at the beginning of period 2 is equivalent to the same payment made at the end of period 1 and so on. Refer to pages 64-92.)

## 94 7: Cash Flow Calculations

## Entering Cash Flows

To enter cash flows into a CFLO list:

1. Press **FIN** **CFLO**. You will see either **FLOW(0)=?** if the current list is empty, or **FLOW(1 or more)=?** if the list is not empty. This is the *bottom* of the current list.

```
FLOW(0)=?  
CALC INSR DELET NAME GET #T?
```

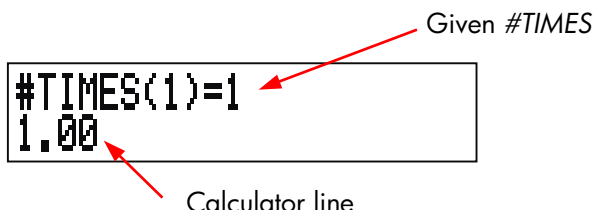
2. If the list is *not* empty, you can do either **a** or **b**:
  - a. Clear the list by pressing **CLR DATA** **YES** (see also page 99.)
  - b. Get a new list by pressing **GET** **\*NEW** (The old list must be named first. Press **NAME** or see page 97.)
3. If the cash flows are *ungrouped* (that is, they are all different), then press **#T?** to turn **#TIMES PROMPTING OFF**. For grouped cash flows, leave this prompting on. (For more information, see "Prompting for #TIMES," next page.)
4. Key in the value of the initial cash flow, *FLOW(0)* (remember that money paid out is negative — use **+/-** to change the sign), and press **INPUT**.\*
5. After briefly showing *FLOW(0)*, the display shows **FLOW(1)=?**. (To view *FLOW(0)* longer, *hold down* **INPUT** before releasing it.) Key in the value for *FLOW(1)* and press **INPUT**. The prompt for the next item appears.
6. **For grouped cash flows:** The display now shows **#TIMES(1)=1**. If it does not, press **EXIT** **#T?** to turn the *#TIMES* prompting on. (See "Prompting for #TIMES," below.) *#TIMES* is the number of consecutive occurrences of *FLOW(1)*. *#TIMES* has

\* You can do calculations with a number before entering it. This does not interfere with the list. When you press **INPUT**, the evaluated expression or number is entered into the list.

## 7: Cash Flow Calculations 95

been automatically set to 1, and 1.00 is displayed on the calculator line. Do either **a** or **b**:

- a. To retain the value 1 and go on to the next flow, press  (or ).
- b. To change #TIMES, key in the number and press .\*



7. Continue entering each cash flow and, for grouped flows, the number of times it occurs. The calculator recognizes the end of the list when a flow is left blank (no value is entered).
8. Press  to end the list and restore the CFLO menu. You can now proceed to correct the list, name the list, get another list, or do calculations with the values.

Use these same instructions to enter additional lists.

**Prompting for #TIMES (#T?).** When the calculator displays #TIMES(1)=1, it is *prompting* you for the number of times the current flow occurs. If *all* your cash flows are different (#TIMES always 1), then you don't need the #TIMES prompt. You can turn the prompting for #TIMES on and off by pressing  in the CFLO menu. This produces a brief message: either #TIMES PROMPTING: OFF, or #TIMES PROMPTING: ON.

While prompting is off, all cash flows you enter will have #TIMES = 1.

When you are viewing a cash-flow list with the #TIMES prompting off, the calculator displays only those #TIMES values that are *not* 1.

\* The maximum #TIMES for each cash flow is 999.

## 96 7: Cash Flow Calculations



The *#TIMES* prompting is usually *on*, because it is automatically turned on whenever you clear or get a cash-flow list.







**Example: Entering Cash Flows.** Enter the following ungrouped cash flows in a list and find the percentage internal rate of return (IRR).


0:    \$-500    2:    \$ 275  
 1:        125    3:        200



<b>Keys:</b>	<b>Display:</b>	<b>Description:</b>
<input type="button" value="FIN"/> <input type="button" value="CFLO"/>		
<input type="button" value="CLR DATA"/>	CLEAR THE LIST?	Asks for confirmation.
<input type="button" value="YES"/>	FLOW(0)=?	Clears data from list and prompts for initial flow.
<input type="button" value="#T?"/>	#TIMES PROMPTING: OFF	Sets prompting off because it is not needed.
500 <input type="button" value="+/-"/> <input type="button" value="INPUT"/>	FLOW(1)=? -500.00	Enters initial flow; then immediately prompts for next flow.
125 <input type="button" value="INPUT"/>	FLOW(2)=? 125.00	Enters <i>FLOW(1)</i> ; prompts for next flow.
275 <input type="button" value="INPUT"/>	FLOW(3)=? 275.00	Enters <i>FLOW(2)</i> ; prompts for next flow.
200 <input type="button" value="INPUT"/>	FLOW(4)=? 200.00	Enters <i>FLOW(3)</i> ; prompts for next flow.
<input type="button" value="EXIT"/> <input type="button" value="CALC"/>	NPV, NUS, NFV NEED I%	Ends list and displays CALC menu.
<input type="button" value="IRR%"/>	IRR%=9.06	Calculates IRR.


### Viewing and Correcting the List


To display a particular list, use  (see page 99).

The  and  keys move up and down one number at a time.  and  display the beginning and end of the list.

**Changing or Clearing a Number.** To change a number after it's been entered: display the number, key in the new value, and press .





Use this same method to clear a number to zero. (Do not press  or , which clear the calculator line, not the cash-flow entry.)

**Inserting Cash Flows into a List.** Insertion occurs *before* (*above*) the current flow. Pressing  inserts a zero cash flow and renumbers the rest of the list. You can then enter a new cash flow and its *#TIMES*.

For example, if *FLOW(6)* is in the display, pressing  puts a new, zero flow between the previously numbered *FLOW(5)* and *FLOW(6)*.

**Deleting Cash Flows from a List.** Pressing  deletes both the current flow and its *#TIMES*.




## Copying a Number from a List to the Calculator Line

To copy a number from the list into the calculator line, use  or  to display the number, then press  .

## Naming and Renaming a Cash-Flow List

A new list has no name. You may name it before or after filling the list, but you *must* name it in order to store another list.

To name a list:

1. Press  from the CFLO menu.
2. Use the ALPHA menu to type a name. (The ALPHA and ALPHA-Edit menus are covered on pages 30 - 32.) To clear a name, press .
3. Press .

## 98 7: Cash Flow Calculations

The name can be up to 22 characters long and include any character except: + - x ÷ ( ) < > : = space \*

But only the first three to five characters (depending on letter widths) of the name are used for a menu label. Avoid names with the same first characters, since their menu labels will look alike.

**Viewing the Name of the Current List.** Press **NAME**, then **EXIT**.

## Starting or GETting Another List

When you press **CFLO**, the cash-flow list that appears is the same as the last one used.

To start a new list or switch to a different one, the current list must be named or cleared. If it is named, then:

1. Press **GET**. The GET menu contains a menu label for each named list plus **\*NEW**.
2. Press the key for the desired list. (**\*NEW** brings up a new, empty list.)

---

## Clearing a Cash-Flow List and Its Name

To clear a list's numbers and name:

1. Display the list you want to clear, then press **CLR DATA** **YES**. This removes the numbers.
2. If the list is named, you'll see **ALSO CLEAR LIST NAME?** Press **YES** to remove the name. Press **NO** to retain the name with an empty list.

\* CFLO does accept these exceptional characters in list names, but the Solver functions SIZEC, FLOW, and #T do not.

To remove just one value at a time from a list, use **DELET**.

---

## Cash-Flow Calculations: IRR, NPV, NUS, NFV

Once you have entered a list of cash flows, you can calculate the following values in the **CALC** menu.

- Sum (*TOTAL*).
- Internal rate of return (*IRR%*). This is a *periodic* rate of return. To calculate an *annual* nominal rate when the period is not a year, multiply the *IRR%* by the number of periods per year.  
If you want the *IRR%* as an *effective* annual rate, then use the **FIN ICNV** menu to convert from the nominal annual rate to the effective annual rate.
- Net present value (*NPV*), net uniform series (*NUS*), and net future value (*NFV*) for a specified, *periodic* interest rate, *I%*.

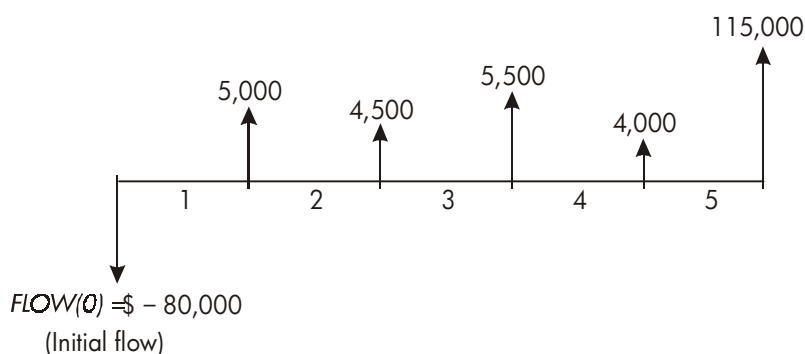
**Table 7-2. The CALC Menu for CFLO Lists**

Menu Label	Description
TOTAL	Calculates the sum of the cash flows.
IRR% *	Calculates the <i>internal rate of return</i> —the interest (discount) rate at which the net present value of the cash flows equals zero.
I%	Stores the <i>periodic interest rate</i> , expressed as a percentage (sometimes called <i>cost of capital</i> , <i>discount rate</i> , or <i>required rate of return</i> ).
NPV	Given <i>I%</i> , calculates the net present value—the present value of a series of cash flows.
NUS	Given <i>I%</i> , calculates the <i>net uniform series</i> —the dollar amount of constant, equal cash flows having a present value equivalent to the net present value.
NFV	Given <i>I%</i> , calculates the <i>net future value</i> of a series of cash flows by finding the future value of the net present value.
<p>* The calculations for internal rate of return are complex and may take a relatively long time. To interrupt the calculation, press any key. In certain cases, the calculator displays a message indicating that the calculation cannot continue without further information from you, or that there is no solution. Refer to appendix B for additional information about calculating <i>IRR%</i>.</p>	

**About the Internal Rate of Return (IRR%).** A “conventional investment” is considered attractive if *IRR%* exceeds the cost of capital. A conventional investment meets two criteria—(1) the sequence of cash flows changes sign only once, and (2) the sum (*TOTAL*) of the cash flows is positive.

Remember that the calculator determines a periodic *IRR%*. If the cash flows occur monthly, then *IRR%* is a monthly value, too. Multiply it by 12 for an annual value.

**Example: Calculating IRR and NPV of an Investment.** An investor makes an initial investment of \$80,000, and expects returns over the next five years as illustrated below.



Calculate the total of the cash flows and the internal rate of return of the investment. In addition, calculate the net present value and net future value, assuming an annual interest rate of 10.5%.

Start the problem with an empty cash-flow list. Since the cash flows are ungrouped, each one occurs just once. Turn off the *#TIMES* prompt to make cash-flow entry faster.

**Keys:**

FIN

CFLO

CLR DATA

YES

or

GET #NEW

#T?

**Display:**

FLOW(0)=?

#TIMES PROMPTING:  
OFF

**Description:**

Displays current cash-flow list and CFLO menu keys.

Clears current list or gets a new one. The empty list prompts for its initial cash flow.

Briefly shows the status of #T? then returns to the list. With prompting off, all cash flows are

**102 7: Cash Flow Calculations**

80000	<input type="button" value="+/-"/>	FLOW(1)=?	assumed to occur just once.
<input type="button" value="INPUT"/>		-80,000.00	Prompts for next cash flow. Calculator line shows last number entered.
5000	<input type="button" value="INPUT"/>	FLOW(2)=?	Stores \$5,000 for <i>FLOW(1)</i> , prompts for next flow.
4500	<input type="button" value="INPUT"/>	FLOW(3)=?	Stores <i>FLOW(2)</i> .
5500	<input type="button" value="INPUT"/>	FLOW(4)=?	Stores <i>FLOW(3)</i> .
4000	<input type="button" value="INPUT"/>	FLOW(5)=?	Stores <i>FLOW(4)</i> .
115000	<input type="button" value="INPUT"/>	FLOW(6)=?	Stores final cash flow and shows end of list.
<input type="button" value="EXIT"/>	<input type="button" value="CALC"/>		Calculates sum of the cash flows.
TOTAL		TOTAL=54,000.00	
IRR%		IRR%=11.93	Calculates internal rate of return.
10.5	<input type="button" value="I%"/>	I%=10.50	Stores periodic interest rate.
NPV		NPV=4,774.63	Calculates <i>NPV</i> .
NFV		NFV=7,865.95	Calculates <i>NFV</i> .

Now calculate the net present value at an interest rate of 10.5% if cash flow #4 is reduced to \$1,000.

<input type="button" value="EXIT"/>		FLOW(6)=?	Displays the bottom of the list.
<input type="button" value="▲"/>	<input type="button" value="▲"/>	FLOW(4)=4,000.00	Moves to cash flow #4.
1000	<input type="button" value="INPUT"/>	FLOW(5)=115,000.00	Changes cash flow #4 to \$1,000.

## 7: Cash Flow Calculations 103

EXIT

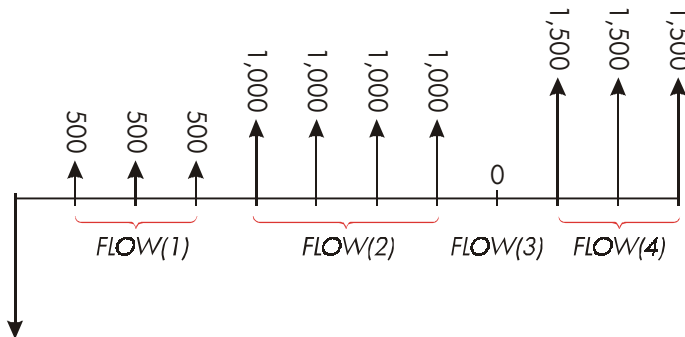
CALC

NPV=2,762.43

Calculates new NPV.

NPV

**Example: An Investment with Grouped Cash Flows.** You are considering an investment that requires a cash outlay of \$9,000, with the promise of monthly cash flows as shown. Calculate *IRR*%. Also find *NPV* and *NFV* at an annual interest rate of 9%.



$FLOW(0) = \$ - 9,000$

Since some of these cash flows are *grouped* (consecutive and equal), the *#TIMES* prompting must be on so you can specify a number other than 1.

Group Number	Amount	Number of Times
Initial	-9,000	-
1	500	3
2	1,000	4
3	0	1
4	1,500	3

**Keys:**

**Display:**

**Description:**

FIN

Current cash-flow list and CFLO menu.

CFLO

CLR DATA

Clears current list. *#TIMES* prompting is turned on.

YES

FLOW(0)=?

## 104 7: Cash Flow Calculations

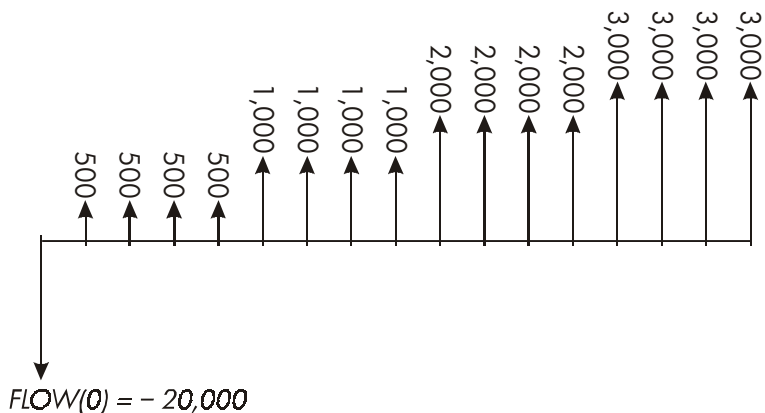


9000	<input type="button" value="+/-"/>	<input type="button" value="INPUT"/>	FLOW(1)=?	Stores the initial cash flow.
500	<input type="button" value="INPUT"/>		#TIMES(1)=1	Stores <i>FLOW(1)</i> and prompts for #TIMES(1).
3	<input type="button" value="INPUT"/>		FLOW(2)=?	<i>FLOW(1)</i> occurs 3 times; prompts for next cash flow.
1000	<input type="button" value="INPUT"/>	4		Stores <i>FLOW(2)</i> four times.
	<input type="button" value="INPUT"/>		FLOW(3)=?	
0	<input type="button" value="INPUT"/>			Stores <i>FLOW(3)</i> one time (the 1 is automatically entered).
	<input type="button" value="INPUT"/>		FLOW(4)=?	
1500	<input type="button" value="INPUT"/>	3		Stores <i>FLOW(4)</i> three times.
	<input type="button" value="INPUT"/>		FLOW(5)=?	
	<input type="button" value="EXIT"/>	<input type="button" value="CALC"/>		Displays the CALC menu.
	<input type="button" value="IRR%"/>		IRR%=1.53	Calculates monthly IRR%.
✓ 9	<input type="button" value="÷"/>	12		Stores the periodic, monthly interest rate.
	<input type="button" value="I%"/>		I%=0.75	
	<input type="button" value="NPV"/>		NPV=492.95	Calculates <i>NPV</i> .
	<input type="button" value="NFV"/>		NFV=535.18	Calculates <i>NFV</i> .

**Example: An Investment with Quarterly Cash Returns.** You have been offered an opportunity to invest \$20,000. The investment returns quarterly payments over four years as follows:

Year 1	4 payments of \$500
Year 2	4 payments of \$1,000
Year 3	4 payments of \$2,000
Year 4	4 payments of \$3,000

## 7: Cash Flow Calculations 105



Calculate the annual rate of return for this investment. (The prompting for #TIMES should be on.)

**Keys:**

FIN CFLO

CLR DATA

YES

or

GET \*NEW

20000 +/-

INPUT

500 INPUT

4 INPUT

1000 INPUT 4

INPUT

2000 INPUT 4

INPUT

3000 INPUT 4

**Display:**

FLOW(0)=?

FLOW(1)=?

#TIMES(1)=1

FLOW(2)=?

**Description:**

Current cash-flow list.

Clears the current list or gets a new one. This sets the #TIMES prompting on.

Stores the initial cash flow.

Stores  $FLOW(1)$ , then prompts for number of times this flow occurs.

$FLOW(1)$  occurs four times.

Stores  $FLOW(2)$ ,  $FLOW(3)$  and  $FLOW(4)$ , and the number of times each flow occurs.

**106 7: Cash Flow Calculations**

INPUT	FLOW(5)=?	
EXIT	CALC	Calculates quarterly rate of return.
IRR%	IRR%=2.43	
✓ (x) 4 (≡)	9.72	Calculates nominal annual rate of return from quarterly rate.

### Doing Other Calculations with CFLO Data

If you would like to do other calculations with cash flows besides those in the CALC menu, you can do so by writing your own Solver equations. There are Solver functions that can access data stored in CFLO lists, and there is a summation function that can combine all or part of the values stored in specific lists.

Refer to “Accessing CFLO and SUM Lists from the Solver” in chapter 12.

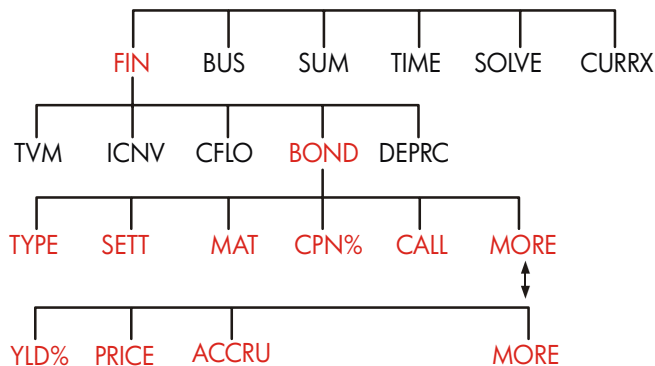
# 8

## Bonds

The BOND menu calculates the *yield to maturity* or *price* of a bond. It also calculates *yield to call* on a coupon date and *accrued interest*. You can specify the:

- *Calendar basis*: 30/360 or actual/actual (days per month/days per year). Municipal, state, and corporate bonds issued in the United States are typically 30/360. U.S. Treasury bonds are actual/actual.
- *Coupon payments*: semi-annual or annual. Most U.S. bonds are semi-annual.

## The BOND Menu





Pressing **BOND** shows you the BOND menu and the type of bond currently specified: **30/360** or **A/A**; **SEMIANNUAL** or **ANNUAL**.

**Table 8-1. BOND Menu Labels**

<b>Menu Label</b>	<b>Description</b>
TYPE	Displays a menu of bond types: 30/360 or actual/actual, semi-annual or annual.
SETT	Stores the settlement (purchase) date according to the current date format (MM.DDYYYY or DD.MMYYYY; see page 143).
MAT	Stores the maturity date or call date according to the current date format. The call date must coincide with a coupon date.
CPN%	Stores the annual coupon rate as a percentage.
CALL	Stores the call price per \$100 face value. For a yield to maturity, make sure CALL equals 100. (A bond at maturity has a "call" value that is 100% of its face value.)
YLD%	Stores or calculates the yield (as an annual percentage) to maturity or yield to call date.
PRICE	Stores or calculates the price per \$100 face value.
ACCRU	Calculates the interest accrued from the last coupon-payment date until the settlement date, per \$100 face value.



The calculator retains the values of the BOND variables until you clear them by pressing  while the BOND menu is displayed. Clearing sets CALL to 100 and all other variables to zero.

To see the value currently stored in a variable, press  menu label.

---

## Doing Bond Calculations

Remember that values in the BOND menu are expressed *per \$100 face value* or as a *percentage*. A *CALL* value of 102 means that the bond will be worth \$102 for every \$100 of face value when called. Some corporate bonds in the United States use the convention that the price of the bond is set to 100 if the coupon rate equals the yield, whether or not the settlement date is a coupon date. The BOND menu does *not* use this convention.

### To calculate the price or yield of a bond:

1. Display the BOND menu: press **FIN** **BOND** .
2. Press **CLR DATA** . This sets *CALL*=100.
3. Define the type of bond. If the message in the display does not match the type you want, press **TYPE** .



- Pressing **360** sets the calendar basis to a 30-day month and a 360-day year.
- Pressing **A/A** sets the calendar basis to the actual calendar month and to the actual calendar year.
- Pressing **SEMI** sets semi-annual coupon payments.
- Pressing **ANN** sets annual coupon payments.

Press **EXIT** to restore the BOND menu.

4. Key in the settlement date (*MM.DDYYYY* or *DD.MMYYYY* depending on the date format; see chapter 11) and press **SETT** .
5. Key in the maturity date or call date and press **MAT** .
6. Key in the coupon rate as an annual percent and press **CPN%** .
7. Key in the call value, if any, and press **CALL** . For a bond held to

## 110 8: Bonds

maturity, the *CALL* value must equal 100. (See step 3.)

8. To calculate a result, first press **MORE** to access the remaining menu labels. Do either **a** or **b**:
  - a. Key in the yield and press **YLD%**. Press **PRICE** to calculate the price.
  - b. Key in the price and press **PRICE**. Press **YLD%** to calculate the yield.

To calculate the accrued interest, press **ACCRU**. The *total* amount owed the seller is  $PRICE + ACCRU$ , that is: **PRICE** **+** **ACCRU** **=**.

**Calculating Fractional Values.** When given a fractional value that must be entered in decimal form, do the arithmetic and then store the result *directly* into a variable. Do not clear the arithmetic and then retype the result before storing it—this is an unnecessary step that can cause incorrect answers due to rounding. See how the following example stores  $8\frac{3}{8}$  in **YLD%**.

**Example: Price and Yield of a Bond.** What price should you pay on August 10, 2003 for a  $6\frac{3}{4}$ % U.S. Treasury bond that matures on May 1, 2018 if you wish a yield of  $8\frac{3}{8}$ %? The calendar basis is actual/actual and the coupon payments are semi-annual. (The example assumes *MM.DDYyyy* date format.)

**Keys:**

**FIN** **BOND**

**CLR DATA**

**TYPE** **A/A**

**SEMI** **EXIT**

8.102003

**SETT**

5.012018

**Display:**

A/A SEMIANNUAL

SETT=

08/10/2003 SUN

**Description:**

Since there is no call on this bond, set *CALL* = 100 by clearing variables.

Sets bond type, if necessary.

Stores settlement (purchase) date.

Stores maturity date.

<input type="text" value="MAT"/>	MAT=05/01/2018	
	TUE	
6.75 <input type="text" value="CPN%"/>	CPN%=6.75	Stores annual coupon rate.
<input type="text" value="MORE"/>		Stores desired yield
✓ <input type="text" value="3"/> <input type="text" value="÷"/> <input type="text" value="8"/> <input type="text" value="+"/> <input type="text" value="8"/>		(displayed rounded to two decimal places).*
<input type="text" value="YLD%"/>	YLD%=8.38	Result: price is \$86.38
<input type="text" value="PRICE"/>	PRICE=86.38	per \$100 face value.
✓ <input type="text" value="+"/> <input type="text" value="ACCRU"/>	86.38+1.85	Adds accrued interest owed the seller.
✓ <input type="text" value="="/>	88.23	Net price.

Suppose that the market quote for the bond is 88¼. What yield does it represent?

88.25 <input type="text" value="PRICE"/>	PRICE=88.25	Stores quoted price.
<input type="text" value="YLD%"/>	YLD%=8.13	Result: yield to maturity.

**Example: A Bond with a Call Feature.** What is the price of a 6% corporate bond maturing on March 3, 2022 and purchased on May 2, 2003 to yield 5.7%? It is callable on March 3, 2006 (a coupon date), at a value of 102.75. What is the yield to the call date? Use a 30/360 calendar with semi-annual coupon payments.

Keys:	Display:	Description:
<input type="text" value="FIN"/> <input type="text" value="BOND"/>		Displays BOND menu,
<input type="text" value="CLR DATA"/>		clears variables.
<input type="text" value="TYPE"/> <input type="text" value="360"/>		Sets bond type, if
<input type="text" value="SEMI"/> <input type="text" value="EXIT"/>	30/360 SEMIANNUAL	necessary.

\* To see the full precision of the number, press .

## 112 8: Bonds



5.022003	SETT	SETT=	Stores purchase date
		05/02/2003 FRI	(MM.DDYYYY format).
3.032022	MAT	MAT=03/03/2022 THU	Stores maturity date.
6	CPN%	CPN%=6.00	Stores annual coupon rate.
	MORE		Stores yield.
5.7	YLD%	YLD%=5.70	
	PRICE	PRICE=103.43	Calculates price.
MORE	3.032006		Changes maturity date
MAT	102.75		to call date and stores
CALL		CALL=102.75	a call value.
MORE	YLD%	YLD%=5.58	Calculates yield to call.

**Example: A Zero-Coupon Bond.** Calculate the price of a zero-coupon, semi-annual bond using a 30/360 calendar basis. The bond was purchased on May 19, 2003 and will mature on June 30, 2017, and has a yield to maturity of 10%.

**Keys:**

**Display:**

**Description:**

FIN BOND

CLR DATA

TYPE 360

SEMI  EXIT 30/360 SEMIANNUAL

5.192003 SETT=

SETT 05/19/2003 MON

6.302017 MAT

MAT=06/30/2017 FRI

0 CPN% CPN%=0.00

MORE 10 YLD% YLD%=10.00

PRICE PRICE=25.23

Clears BOND variables, setting CALL to 100.

Sets type if necessary (check the display).

Purchase date (MM.DDYYYY format).

Maturity date.

Coupon rate is zero.

Yield to maturity.

Calculates price.

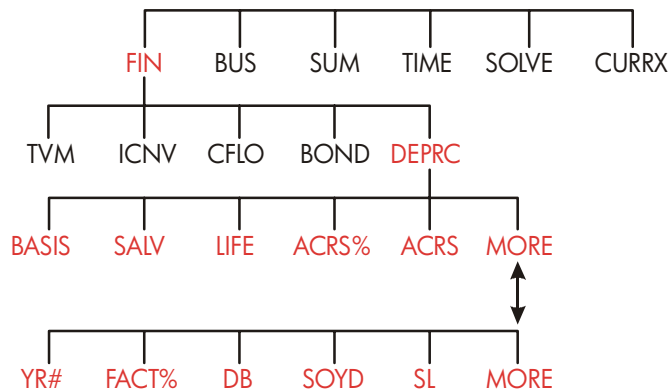
# 9

## Depreciation

The DEPRC (*depreciation*) menu calculates depreciation values and remaining depreciable values one year at a time. The methods available are:

- Declining balance.
- Sum-of-the-years' digits.
- Straight line.
- Accelerated Cost Recovery System.


### The DEPRC Menu




Pressing **DEPRC** displays the DEPRC menu.

### 114 9: Depreciation

**Table 9-1. DEPRC Menu Labels**

Menu Label	Description
BASIS	Stores the depreciable cost basis of the asset at acquisition.
SALV	Stores the salvage value of the asset at the end of its useful life. If there is no salvage value, set SALV=0.
LIFE	Stores the expected useful life (in whole years) of the asset.
ACRS%	Stores the appropriate Accelerated Cost Recovery System percentage from the published ACRS tables.
ACRS	Calculates the ACRS deduction based on BASIS and ACRS%. (The values in SALV, LIFE, FACT%, and YR# do not matter.)
	
	Stores the number of the year for which you want the depreciation (1, 2, etc.).
YR#	
FACT%	Stores the declining-balance factor as a percentage of the straight-line rate. <i>This is for the DB method only.</i> For example, for a rate 1¼ times (125%) the straight-line rate, enter 125.
DB	Calculates the declining-balance depreciation for the year.
SOYD	Calculates the sum-of-the-years'-digits depreciation for the year.
SL	Calculates the straight-line depreciation for the year.
▼	Displays the remaining depreciable value, RDV, after you have pressed <b>DB</b> , <b>SOYD</b> , or <b>SL</b> .

The calculator retains the values of the DEPRC variables until you clear them by pressing  while the DEPRC menu is displayed.

To see the value currently stored in a variable, press **RCL** menu label.

---

## Doing Depreciation Calculations

### DB, SOYD, and SL Methods

**To calculate the depreciation for an asset:\***

1. Display the DEPRC menu: press **FIN** **DEPRC**.
2. Define the characteristics of the asset:
  - a. Key in the cost basis and press **BASIS**.
  - b. Key in the salvage value and press **SALV**. If there is no salvage value, enter zero.
  - c. Key in the useful life and press **LIFE**.
3. Press **MORE** for the rest of the DEPRC menu.
4. Key in the number for the year of depreciation you want to calculate (1, 2, 3, etc.) and press **YR#**.
5. If you are using the declining-balance method, enter the DB factor (a percentage) and press **FACT%**.
6. Press **DB**, **SOYD**, or **SL** to calculate the appropriate depreciation.
7. To see the remaining depreciable value (basis — salvage value — accumulated depreciation), press **▼**.
8. To calculate the depreciation for another year, just change **YR#** and press **DB**, **SOYD**, or **SL** again.

\* The calculated values of *RDV*, *DB*, *SOYD*, and *SL* are rounded internally to the number of decimal places specified by the current display setting. A setting of **FIX 2** means that these values will be rounded internally to two decimal places.

## 116 9: Depreciation

**Example: Declining-Balance Depreciation.** A metalworking machine, purchased for \$10,000, is to be depreciated over 5 years. Its salvage value is estimated at \$500. Find the depreciation and remaining depreciable value for each of the first 3 years of the machine's life using the double-declining-balance method (200% of the straight-line rate). For comparison, find the straight-line depreciation, as well.

<b>Keys:</b>	<b>Display:</b>	<b>Description:</b>
FIN DEPRC		Displays DEPRC menu.
10000 BASIS	BASIS=10,000.00	Cost basis.
500 SALV	SALV=500.00	Salvage value.
5 LIFE	LIFE=5.00	Useful life.
MORE 1 YR#	YR#=1.00	First year of depreciation.
200 FACT%	FACT%=200.00	DB percentage factor.
DB	DB=4,000.00	Depreciation in first year. (Salvage value ignored at this point.)
▼	RDV=5,500.00	Remaining depreciable value after first year (BASIS - SALV - 4,000).
2 YR# DB	DB=2,400.00	Depreciation in second year.
▼	RDV=3,100.00	Remaining depreciable value after second year.
3 YR# DB	DB=1,440.00	Depreciation in third year.
▼	RDV=1,660.00	Remaining depreciable value after third year.
SL	SL=1,900.00	Straight-line depreciation for each year.

## 9: Depreciation 117



RDV=3,800.00

Remaining depreciable value after third year using SL.

## The ACRS Method

To calculate the amount of tax deduction under the U.S. Accelerated Cost Recovery System:

1. Display the DEPRC menu: press **FIN** **DEPRC**.
2. Enter the cost basis of the asset and press **BASIS**.
3. The Internal Revenue Service publishes tables that list the percentage of an asset's basis that can be deducted each year of its prescribed life. Look up that value, enter it, and press **ACRS%**.
4. Press **ACRS** to calculate the value of the deduction.

**Example: ACRS Deductions.** Use the ACRS method to find the income-tax deduction for a \$25,000 asset over 3 years of a 5-year life. Use this hypothetical ACRS table:

Year	Percentage Deductible
1	15
2	25
3	20
4	20
5	20

### Keys:

**FIN** **DEPRC**

25000 **BASIS**

15 **ACRS%**

**ACRS**

### Display:

**BASIS**=25,000.00

**ACRS%**=15.00

**ACRS**=3,750.00

### Description:

DEPRC menu.

Enters basis.

Tabular value, year 1.

Deduction in first year.

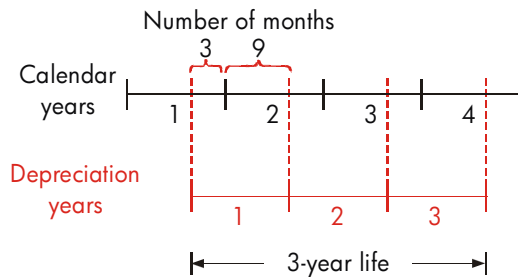
## 118 9: Depreciation

25 ACRS%	ACRS%=25.00	Tabular value, year 2.
ACRS	ACRS=6,250.00	Deduction in second year.
20 ACRS%	ACRS%=20.00	Tabular value, year 3.
ACRS	ACRS=5,000.00	Deduction in third year.

## Partial-Year Depreciation

When the acquisition date of an asset does not coincide with the start of the tax or fiscal year, then the amounts of depreciation in the first and last years are computed as fractions of a full year's depreciation. Except in SL, the intermediate years are computed as sums of fractions. This does not apply to the ACRS method.

Suppose you acquired an asset in October and wanted to depreciate it for 3 years. (Your fiscal year begins January 1st.) The depreciation schedule would affect parts of 4 years, as shown in the illustration. The 3 months from October to December equal  $\frac{1}{4}$  year.



For SL depreciation, partial-year calculations are easy: calculate the SL value, then use  $\frac{1}{4}$  of that value for the first year, the full amount the second and third years, and  $\frac{3}{4}$  of that amount the fourth year.

For DB and SOYD depreciation, each year's depreciation value is different, as shown in the table:

Calendar Year	Depreciation Value
1 (Oct.-Dec.)	$\frac{1}{4} \times \text{year 1}$
2	$(\frac{3}{4} \times \text{year 1}) + (\frac{1}{4} \times \text{year 2})$
3	$(\frac{3}{4} \times \text{year 2}) + (\frac{1}{4} \times \text{year 3})$
4 (Jan.-Sept.)	$\frac{3}{4} \times \text{year 3}$

**Example: Partial-Year Depreciation.** A movie camera bought for \$12,000 has a useful life of 10 years with a salvage value of \$500. Using the sum-of-the-years'-digits method, find the amount of depreciation for the fourth year. Assume the first depreciation year was 11 months long.

**Keys:**

**Display:**

**Description:**

FIN DEPRC

Displays DEPRC menu.

12000 BASIS

Stores known values.

500 SALV

10 LIFE

MORE 3 YR# YR#=3.00

SOYD SOYD=1,672.72

Calculates depreciation for year 3.

✓  $\div$  12  $\equiv$  (STO) 1 139.39

Stores 1 month's depreciation from year 3.

4 YR# SOYD SOYD=1,463.64

Calculates depreciation for year 4.

✓  $\times$  11  $\div$  12  $\equiv$  1,341.67

Figures 11 months' depreciation from year 4.

✓  $+$  (RCL) 1  $\equiv$  1,481.06

Figures total depreciation for year 4.

**120 9: Depreciation**



# 10

## Running Total and Statistics

---

The SUM menu stores and statistically analyzes sets of numbers. As you enter the numbers, the calculator displays their running total. Once you've entered the numbers into a *list*, you can:

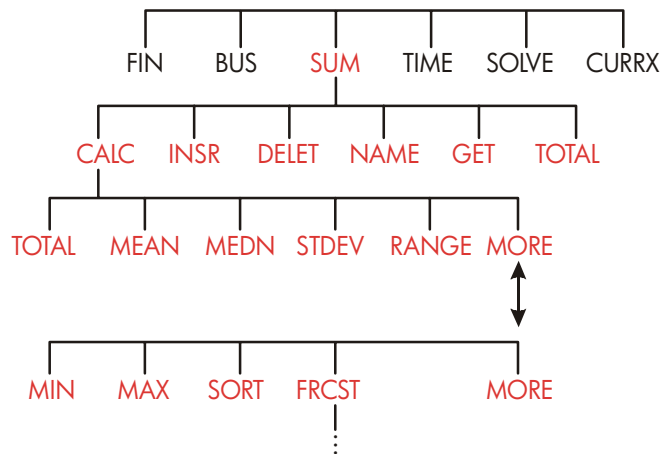
- Calculate the mean, median, standard deviation, and range.
- Display the largest and smallest number in the list.
- Sort the list from smallest number to largest number.

With two lists of numbers, you can:

- Do curve-fitting and forecasting calculations using two SUM lists and one of four models—linear, exponential, logarithmic, and power. (Curve fitting for the linear model is called *linear regression*.)
- Calculate the weighted mean and grouped standard deviation.
- Find the summation statistics ( $\Sigma x$ ,  $\Sigma x^2$ ,  $\Sigma y$ ,  $\Sigma y^2$ ,  $\Sigma xy$ ).

You can store many separate lists of numbers in SUM. The maximum number depends on the amount of available calculator memory.

## The SUM Menu



The SUM menu creates lists of numbers and performs calculations with a SUM list.

**Table 10-1. SUM Menu Labels**

Menu Label	Description
CALC	Accesses the CALC menu to calculate the total, mean, median, standard deviation, range, minimum, maximum, sorting, and linear regression (including weighted mean and summation statistics).
INSR	Allows you to insert numbers into the list.
DELET	Deletes numbers from the list.
NAME	Allows you to name the list.
GET	Allows you to switch from one named list to another or to create a new list.
TOTAL	Displays the total of all the items in the list.

## 122 10: Running Total and Statistics

To see the calculator line when this menu is in the display, press **INPUT** once. (This does not affect number entry.)

To see this menu when the calculator line is in the display, press **EXIT**.

---

## Creating a SUM List

To keep a running total of a list of numbers or do statistical calculations with sets of data, first create a SUM list of the values.

### Entering Numbers and Viewing the TOTAL

To enter numbers into a SUM list:

1. Press **SUM**. You'll see **ITEM(1)=?** if the current list is empty, or **ITEM(2 or more)=?** if the list is not empty. This is the *bottom* of the current list.



The image shows a calculator display with the text "ITEM(1)=?" on the top line. Below it, a menu bar contains the following options: "CALC", "INSR", "DELET", "NAME", "GET", and "TOTAL".

2. If the list is empty, start filling it (step 3). If the current list is *not* empty, you can do either **a** or **b**:
  - a. Clear the list by pressing **CLR DATA** **YES** (see also page 127.)
  - b. Get a new list by pressing **GET** **\*NEW** (The old list must be named first. Press **NAME** or see page 126.)
3. Key in the value of the first item, *ITEM(1)* (press **+/-** for a negative number), and press **INPUT**.\* (To view *ITEM(1)* longer, hold down **INPUT** before releasing it.)

\* Remember that you can do calculations with a number before entering it. This does not interfere with the list. Whenever you press **INPUT**, the number (or evaluated expression) in the calculator line is entered into the list. If you need to use the MATH menu, just press **MATH**, do the calculation, then press **EXIT** to return to where you were in SUM.

After briefly showing *ITEM(1)*, the display shows

ITEM(2)=?

TOTAL=*number*

*TOTAL* is the updated, running *TOTAL* of all the numbers in the list (only one number, so far).

4. To enter *ITEM(2)*, key in the value and press **INPUT**. The prompt for *ITEM(3)* and the new, updated total appear.
5. Continue entering values for *ITEM(3)*, *ITEM(4)*, etc. The calculator recognizes the end of the list when an item is left blank (no value is entered).
6. Press **EXIT** to end the list and restore the SUM menu. You can now proceed to correct the list, name the list, get another list, or do statistical calculations.

Use these same instructions to enter additional lists.

## Viewing and Correcting the List

To display a particular list, use **GET** (see page 127).

The **▲** and **▼** keys move up and down the list one number at a time. **◀▲** and **▶▼** display the beginning and end of the list.

**Changing or Clearing a Number.** To change a number after it's been entered: display the number, key in the new value, and press **INPUT**.

Use the same method to clear a number to zero. (Do not press **CLR** or **↵**, which clears the calculator line.)

**Inserting Numbers into a List.** Insertion occurs *before* (or *above*) the current entry. Pressing **INSR** inserts a zero item and renumbers the rest of the list. You can then enter a new value.

For example, if *ITEM(6)* is in the display, pressing **INSR** puts a new, zero item between the previously numbered *ITEM(5)* and *ITEM(6)*.

## 124 10: Running Total and Statistics

**Deleting Numbers from a List.** Pressing **DELET** deletes the current item.

**Example: Updating a Checkbook.** On May 31, your checking account balance was \$267.82. The transactions for the first 10 days in June are:

Date	Transaction	Amount	Date	Transaction	Amount
6/1	Balance	267.82	6/3	Check	-128.90
6/1	Deposit	837.42	6/7	Check	-65.35
6/1	Check	-368.23	6/10	Deposit	55.67
6/2	Check	-45.36			

Update the checkbook by calculating the running balance.

**Keys:**

**Display:**

**Description:**

<b>SUM</b> *			
<input type="checkbox"/> <b>CLR DATA</b>	<b>YES</b>	ITEM(1)=?	Displays empty SUM list.
267.82	<input type="text" value="INPUT"/>	ITEM(2)=?	Enters beginning balance and shows running total.
		TOTAL=267.82	
837.42	<input type="text" value="INPUT"/>	ITEM(3)=?	Enters deposit on 6/1.
		TOTAL=1,105.24	
368.23	<input type="text" value="+/-"/>		Enters remaining transactions.
	<input type="text" value="INPUT"/>		
45.36	<input type="text" value="+/-"/>		
	<input type="text" value="INPUT"/>		
128.90	<input type="text" value="+/-"/>		
	<input type="text" value="INPUT"/>		
65.35	<input type="text" value="+/-"/>		
	<input type="text" value="INPUT"/>		

\* If you want to preserve the current list, skip the next step (pressing  **CLR DATA**). Instead, name the list and then press **GET** **\*NEW**.

**10: Running Total and Statistics 125**

55.67  ITEM(8)=?  
TOTAL=553.07

ITEM(8)=?                      Ends list and displays  
SUM menu again.

## Copying a Number from a List to the Calculator Line

To copy a number from the list into the calculator line, use  or  to display the number, then press  .

## Naming and Renaming a SUM List

A new list has no name. You may name it before or after filling the list, but you *must* name it in order to store another list.

To name a list:

1. Press  from the SUM menu.
2. Use the ALPHA menu to type in a name. (The ALPHA and ALPHA-Edit menus are covered on pages 30 - 32.) To clear a name, press .
3. Press .

The name can be up to 22 characters long and include any character except: + - x ÷ ( ) < > : = space \*

But only the first three to five characters (depending on letter widths) of the name are used for a menu label. Avoid names with the same first characters, since their menu labels will look alike.

**Viewing the Name of the Current List.** Press , then .

\* SUM does accept these exceptional characters in list names, but the Solver functions SIZES and ITEM do not.

## 126 10: Running Total and Statistics

## Starting or GETting Another List

When you press **SUM**, the SUM list that appears is the last one used.

To start a new list or switch to a different one, the current list must be named or cleared. If it is named, then:

1. Press **GET**. The GET menu contains a menu label for each named list plus **\*NEW**.
2. Press the key for the desired list. (**\*NEW** brings up a new, empty list.)

---

## Clearing a SUM List and Its Name

To clear a list's numbers and name:

1. Display the list you want to clear, then press **CLR DATA** **YES**. This removes the numbers.
2. If the list is named, you'll see **ALSO CLEAR LIST NAME?** Press **YES** to remove the name. Press **NO** to retain the name with an empty list.

To remove just one value at a time from a list, use **DELET**.

---

## Doing Statistical Calculations (CALC)


Once you have entered a list of numbers, you can calculate the following values.

- **For one variable:** the total, mean, median, standard deviation, range, minimum, and maximum. You can also sort the numbers in order of increasing value.
- **For two variables:** *x*-estimates and *y*-estimates (this is also called *forecasting*), the correlation coefficient for different types of curves (this is *curve-fitting*), the slope and *y*-intercept of the line, and summation statistics. You can also find the weighted mean and the grouped standard deviation.

## Calculations with One Variable

The CALC menu calculates the following statistical values using one SUM list.

**Table 10-2. The CALC Menu for SUM Lists**

Menu Key	Description
TOTAL	Calculates the sum of the numbers in the list.
MEAN	Calculates the arithmetic mean (average).
MEDN	Calculates the median.
STDEV	Calculates the standard deviation.*
RANG	Calculates the difference between the largest and smallest number.
	
MIN	Finds the smallest (minimum) number in the list.
MAX	Finds the largest (maximum) number in the list.
SORT	Sorts the list in ascending order.
FRCST	Displays a series of menus for calculations with two variables for curve fitting, estimation, weighted mean and grouped standard deviation, and summation statistics.
<p>* The calculator finds the <i>sample</i> standard deviation. The formula assumes that the list of numbers is a sampling of a larger, complete set of data. If the list is, in fact, the entire set of data, the <i>true population standard deviation</i> can be computed by calculating the mean of the original list, placing that value into the list, and then calculating the standard deviation.</p>	

**Example: Mean, Median, and Standard Deviation.** Suppose your shop had the following phone bills during the past six months:

### 128 10: Running Total and Statistics



Month	Phone Expense	Month	Phone Expense
1. May	\$340	4. August	\$780
2. June	\$175	5. September	\$245
3. July	\$450	6. October	\$625

Calculate the mean, median, and standard deviation of the monthly phone bills. Then display the smallest value in the list.

**Keys:**

or

340

175

450

780

245

625

**Display:**

ITEM(1)=?

ITEM(2)=?

TOTAL=340.00

ITEM(3)=?

TOTAL=515.00

ITEM(7)=?

TOTAL=2,615.00

2,615.00

MEAN=435.83

MEDIAN=395.00

STDEV=231.55

**Description:**

Displays current SUM list and SUM menu keys.

Clears current list or gets a new one.

Stores May's phone bill; shows total.

Stores June; updates total.

Stores phone bills for July-October and keeps a running total.

Displays CALC menu.

Calculates mean.

Calculates median.

Calculates standard

**10: Running Total and Statistics 129**

MORE

deviation.

Displays rest of CALC menu.

MIN

MIN=175.00

Finds smallest number.

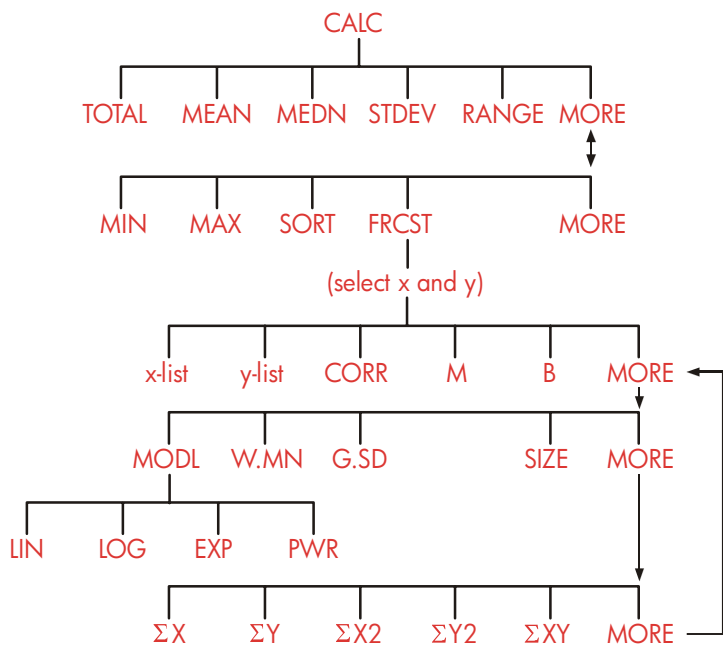
---

## Calculations with Two Variables (FRCST)

The FRCST menu does the following two-variable calculations using two SUM lists:



- Fits  $x$ - and  $y$ -data to a linear, logarithmic, exponential, or power curve.
- Forecasts estimated values based on that curve.
- Finds the weighted mean and grouped standard deviation.
- Shows you the summation statistics ( $\Sigma x$ ,  $\Sigma x^2$ ,  $\Sigma y$ ,  $\Sigma y^2$ ,  $\Sigma xy$ , etc.).

### 130 10: Running Total and Statistics



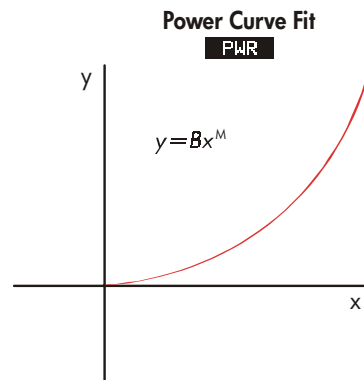
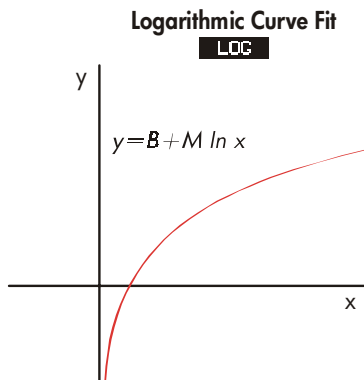
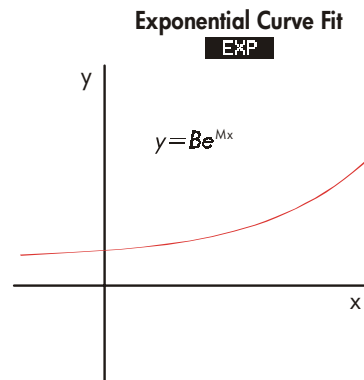
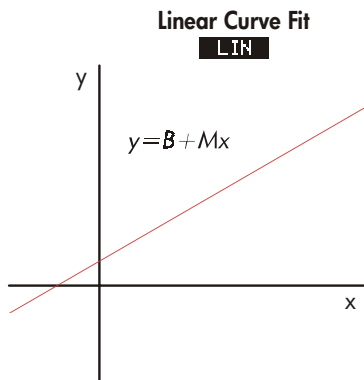
After pressing **FRCST**, you must specify two previously created lists—one for the x-variable and one for the y-variable. The two lists must have the same number of items.

**Table 10-3. FRCST Menu Labels**

Menu Label	Description
<i>list name for x-variable</i> <i>list name for y-variable</i>	These specify the two lists of data to be compared. Also used for estimations: store $x$ and estimate $y$ , or vice-versa. <code>*CURR</code> is the menu label for an unnamed current list.
<code>CORR</code> *	Calculates the <i>correlation coefficient</i> , a number between $-1$ and $+1$ that measures how closely the $x,y$ data points match the calculated curve.
<code>M</code> *	Calculates $M$ . For the linear model, this is the slope.
<code>B</code> *	Calculates $B$ . For the linear model, this is the $y$ -intercept.
<code>MODL</code>	<div style="text-align: center;">  <span style="border: 1px solid gray; padding: 2px 5px;">MORE</span> </div> Displays a choice of the four curve-fitting models:
<code>W.MN</code>	<div style="text-align: center;"> <span style="border: 1px solid gray; padding: 2px 5px;">LIN</span> , <span style="border: 1px solid gray; padding: 2px 5px;">LOG</span> , <span style="border: 1px solid gray; padding: 2px 5px;">EXP</span> , and <span style="border: 1px solid gray; padding: 2px 5px;">PWR</span> .         </div> Calculates the weighted mean of the $x$ -values using the weights in the $y$ -list.
<code>G.SD</code>	Calculates the standard deviation of a set of $x$ -values grouped by frequencies specified in the $y$ -list.
<code>SIZE</code>	The number of items in either list.
<code>ΣX</code>	<div style="text-align: center;">  <span style="border: 1px solid gray; padding: 2px 5px;">MORE</span> </div> Sum of items in $x$ -list.
<code>ΣY</code>	Sum of items in $y$ -list.
<code>ΣX<sup>2</sup></code>	Sum of squares of items in $x$ -list.
<code>ΣY<sup>2</sup></code>	Sum of squares of items in $y$ -list.
<code>ΣXY</code>	Sum of products of items in $x$ - and $y$ -lists.
* For the non-linear models, the calculation uses the <i>transformed</i> data values.	

## Curve Fitting and Forecasting

Curve fitting is a statistical method for finding a relationship between two variables,  $x$  and  $y$ . Based on this relationship, you can *estimate* new values of  $y$  based on a given  $x$ -value, and vice-versa. Each SUM list holds the numbers (data values) for one variable. You can select one of four curve-fitting *models*:\*



\* The exponential, logarithmic, and power models are calculated using transformations that allow the data to be fitted by standard linear regression. The equations for these transformations appear in appendix B. The logarithmic model requires positive  $x$ -values; the exponential model requires positive  $y$ -values; and the power curve requires positive  $x$ - and  $y$ -values.

### To do curve fitting and forecasting :

1. Enter the data into two SUM lists: one for the  $x$ -values and one for the  $y$ -values. Make sure each list has the same number of items so that the items are in matched pairs.
2. From the SUM menu, press **CALC** **MORE** **FRCST** to display a menu of SUM-list names. The current list is labeled **\*CURR** unless named otherwise.
3. Press a menu key to select a list of  $x$ -values (*independent variable*).
4. Select a list of  $y$ -values (*dependent variable*).
5. Now you see the FRCST menu. Whichever curve-fitting model was used last is named in the display. If you want to select a different model, press **MORE** **MODL** , and then the menu key for the model.



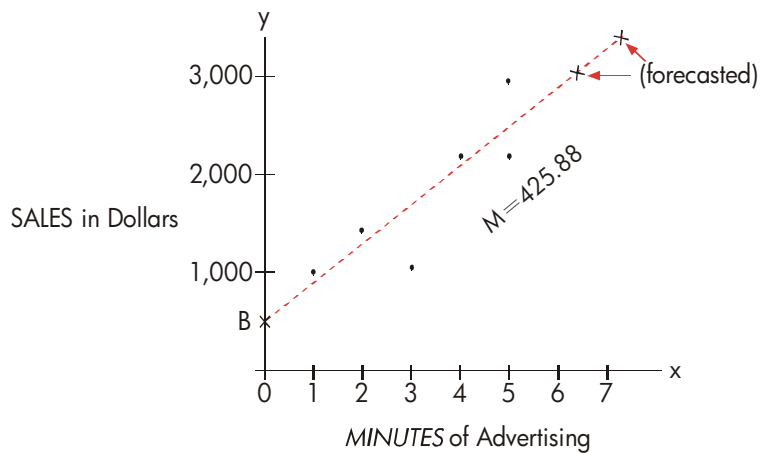
LINEAR  
MINU SALES CORR M E MORE

6. To calculate the curve-fitting results, press, **CORR** , **M** and **E** .
7. To forecast (estimate) a value:
  - a. Key in the known value and press the menu key for that variable.
  - b. Press the menu key for the variable whose value you want to forecast.

**Example: Curve Fitting.** BJ's Dahlia Garden advertises on a local radio station. For the past six weeks, the manager has kept records of the number of minutes of advertising that were purchased, and the sales for that week.

	<b>Number of Minutes of Radio Advertising (x-values, MINUTES)</b>	<b>Dollar Sales (y-values, SALES)</b>
Week 1	2	\$1,400
Week 2	1	\$ 920
Week 3	3	\$1,100
Week 4	5	\$2,265
Week 5	5	\$2,890
Week 6	4	\$2,200

BJ's wants to determine whether there is a linear relationship between the amount of radio advertising and the weekly sales. If a strong relationship exists, BJ's wants to use the relationship to forecast sales. A graph of the data looks like this:



## 10: Running Total and Statistics 135

**Keys:****SUM****CLR DATA****YES**2 **INPUT**1 **INPUT**3 **INPUT**5 **INPUT**5 **INPUT**4 **INPUT****EXIT** **NAME**

MINUTES

**INPUT**

Now enter and name the second list.

**GET** **\*NEW**1400 **INPUT**920 **INPUT**1100 **INPUT**2265 **INPUT**2890 **INPUT**2200 **INPUT****EXIT** **NAME**SALES **INPUT****CALC** **MORE****FRCST****Display:**

ITEM(1)=?

ITEM(7)=?

TOTAL=20.00

TYPE A NAME : [INPUT]

ITEM(7)=?

ITEM(1)=?

ITEM(7)=?

TOTAL=10,775.00

TYPE A NAME : [INPUT]

ITEM(7)=?

SELECT X VARIABLE

**Description:**

Displays current SUM list and SUM menu keys.

Clears current list.

Stores minutes of advertising (x-values) into a SUM list.

Names this list. (See page 30 to use the ALPHA menu.)

Gets a new, empty list.

Stores weekly sales (y-values) into a second SUM list.

Names y-list.

Identifies the lists for curve-fitting.

**136 10: Running Total and Statistics**



<b>MINU</b>	<b>SELECT Y VARIABLE</b>	Selects <i>MINUTES</i> as x-list,
<b>SALES</b>	<b>LINEAR *</b>	<i>SALES</i> as y-list, indicates current curve-fitting model, and displays FRCST menu.
<b>CORR</b>	<b>CORR=0.90</b>	Correlation coefficient for linear model.

The correlation coefficient calculated above is acceptable to BJ's. Using the linear model, estimate what the level of sales would be if the business purchased 7 minutes of advertising time per week.

7 <b>MINU</b>	<b>MINUTES=7.00</b>	Stores 7 in variable <i>MINUTES</i> .
<b>SALES</b>	<b>SALES=3,357.38</b>	Forecasts the sales resulting from 7 minutes of radio advertising.

How many minutes of advertising should BJ's buy if it wants to attain sales of \$3,000?

3000 <b>SALES</b>		The business should buy about 6 minutes of advertising for sales of \$3,000.†
<b>MINU</b>	<b>MINUTES=6.16</b>	

\* If the model named here is not the one you want to use, press **MORE** **MODL** and select the one you want.

† This result is not the same as it would be if *SALES* were the independent (x) variable, and *MINUTES* were the dependent (y) variable.

## 10: Running Total and Statistics 137

## Weighted Mean and Grouped Standard Deviation

Data in one list ( $x$ ) can be weighted or grouped (by frequency) by data in another list ( $y$ ). To find the mean of weighted data and the standard deviation of grouped data:

1. Enter the data values—the  $x$ -variable—into a SUM list.
2. Enter the corresponding weights or frequencies—the  $y$ -variables—into another list. (To calculate  $G.SD$ , the  $y$ -values should be integers.)
3. From the SUM menu, press `CALC` `MORE` `FRCST` to display a menu of SUM-list names. The current list is `*CURR` unless named otherwise.
4. Press the menu key for the list of  $x$ -values.
5. Now select the list with the weights (or frequencies) ( $y$ ).
6. To calculate the weighted mean, press `MORE` `W.MN`.
7. To calculate the grouped standard deviation, press `G.SD`.

**Example: Weighted Mean.** A survey of 266 one-bedroom rental apartments reveals that 54 of them rent for \$200 per month, 32 for \$205, 88 for \$210, and 92 for \$216. What is the average monthly rent and its standard deviation?

Create two SUM lists. The first, called RENT, should contain the numbers 200, 205, 210, and 216, in that order. The second can be unnamed and should contain the numbers 54, 32, 88, and 92, in that order.

Keys:	Display:	Description:
<code>SUM</code>		
<code>CLR DATA</code>		Clears current list or gets a new one.
<code>YES</code>		
or		
<code>GET</code> <code>*NEW</code>	<code>ITEM(1)=?</code>	
200	<code>INPUT</code>	Stores rents into a list.
205	<code>INPUT</code>	
210	<code>INPUT</code>	

## 138 10: Running Total and Statistics

216	<input type="button" value="INPUT"/>	ITEM(5)=? TOTAL=831.00	
	<input type="button" value="EXIT"/> <input type="button" value="NAME"/>		Names this list RENT. (See page 30 to use the ALPHA menu.)
	RENT <input type="button" value="INPUT"/>	ITEM(5)=?	
	<input type="button" value="GET"/> <input type="button" value="NEW"/>	ITEM(1)=?	Gets a new, empty list.
54	<input type="button" value="INPUT"/>		Stores frequencies into second list.
32	<input type="button" value="INPUT"/>		
88	<input type="button" value="INPUT"/>		
92	<input type="button" value="INPUT"/>	ITEM(5)=? TOTAL=266.00	
	<input type="button" value="EXIT"/> <input type="button" value="CALC"/>		Displays names of all SUM lists.
	<input type="button" value="MORE"/> <input type="button" value="FRCST"/>	SELECT X VARIABLE	
	<input type="button" value="RENT"/>	SELECT Y VARIABLE	Specifies <i>RENT</i> as the x-list.
	<input type="button" value="CURR"/>	LINEAR	Specifies the current, unnamed list as the y-list and then displays the FRCST menu. (Ignore model type.)
	<input type="button" value="MORE"/> <input type="button" value="W.MN"/>	209.44	Average monthly rent.
	<input type="button" value="G.SD"/>	5.97	Standard deviation of the rents.

## Summation Statistics

The summation values are of interest if you want to perform other statistical calculations besides those provided by the calculator. To find  $\Sigma x$ ,  $\Sigma x^2$ ,  $\Sigma y$ ,  $\Sigma y^2$ ,  $\Sigma(xy)$ , and  $n$ , the number of elements in either list:

1. Display the FRCST menu and select the x- and y-lists as explained in steps 1-4 of the instructions on page 134. To find the summation

## 10: Running Total and Statistics 139

statistics for just one list of data, specify the same list for both  $x$  and  $y$ .

2. To see  $n$ , press **MORE** **SIZE** .
3. Press **MORE** again to display the summation menu, and press the menu label for the value you want.

## Doing Other Calculations with SUM Data

If you would like to do other statistical calculations with SUM data besides those in the CALC menu, you can do so by writing your own Solver equation. There are Solver functions that can access data stored in SUM lists, and there is a summation function that can combine all or part of the values stored in specific lists.

Refer to “Accessing CFLO and SUM Lists from the Solver” in chapter 12.

# 11

## Time, Appointments, and Date Arithmetic

---

The calculator contains a clock and calendar in the TIME menu. You can select a 12-hour or 24-hour clock, and a month-day-year or day-month-year calendar. You can:

- Record appointments that set alarms with optional messages.
- Determine the day of the week for a particular date.
- Calculate the number of days between two dates using the 360-day, the 365-day, or the actual calendar.

---

### Viewing the Time and Date

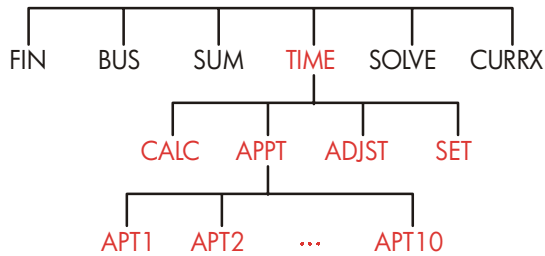
To view the time and date, press **TIME** in the MAIN menu.



```
TUE 05/20/03 01:30:26P
CALC APPT ADJUST SET
```

If you overwrite the time and date, you can restore them to the display by pressing **CLR**.

## The TIME Menu



**Table 11-1. The TIME Menu Labels**

<b>Menu Label</b>	<b>Description</b>
<b>CALC</b>	Displays the CALC menu, for calculating the day of the week and other date arithmetic.
<b>APPT</b>	Displays the APPT menu for setting and viewing appointments.
<b>ADJST</b>	Displays the ADJST menu for adjusting the clock setting.
<b>SET</b>	Displays the SET menu for setting the time and date, and for selecting the time and date formats.

---

## Setting the Time and Date (SET)

**Table 11-2. The SET Menu Labels**

<b>Menu Label</b>	<b>Description</b>
<b>DATE</b>	Sets the date to the displayed number ( <i>MM.DDYYYY</i> or <i>DD.MMYYYY</i> ).
<b>TIME</b>	Sets the time to the displayed number ( <i>HH.MMSS</i> ).
<b>A/PM</b>	Switches between AM and PM (12-hour clock).
<b>M/D</b>	Switches between month/day/year and day.month.year formats.
<b>12/24</b>	Switches between 12-hour and 24-hour clock formats.
<b>HELP</b>	Displays the formats for entering the clock's date and time.

### To set the time:

1. Press **TIME** **SET** to display the SET menu.
2. Key in the correct time in the current format (A or P indicates the 12-hour clock). For example, for 9:08:30 p.m. enter 9.0830 in a 12-hour clock or 21.0830 in a 24-hour clock.
3. Press **TIME** to set the new time.
4. For 12-hour format: press **A/PM** to switch between AM and PM.

### To set the date:

1. Key in the correct date in the current format. For example, for April 3, 2003 enter 4.032003 in month/day/year format or 3.042003 in day.month.year format.
2. Press **DATE**.

## 11: Time, Appointments, and Date Arithmetic 143

**Example: Setting the Date and Time.** Set the date and time to April 5, 2003, 4:07 p.m.

<b>Keys:</b>	<b>Display:</b>	<b>Description:</b>
<b>SET</b>		Displays SET menu.
4.052003 <b>DATE</b>	SAT 04/05/03	Sets date.
4.07 <b>TIME</b> <b>A/PM</b>	SAT 04/05/03 04:07:xxP	Sets time. Press <b>A/PM</b> if necessary.

## Changing the Time and Date Formats (SET)

Use the SET menu to change the time and date formats. To switch between the 12- and 24-hour clocks, press **12/24**. To switch between the month/day/year and day.month.year calendars, press **M/D**.

## Adjusting the Clock Setting (ADJST)

The ADJST menu adjusts the time setting forward or backward in increments of hours, minutes, or seconds.

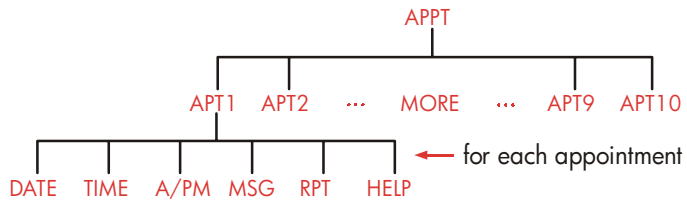
1. Press **TIME** **ADJST**.
2. Press the appropriate menu key(s) until the correct time is displayed. For example, if the current time setting is 11:20:xx AM (ignoring seconds), pressing **+HR** twice changes the time to 1:20 PM. Then, pressing **-MIN** three times changes the time to 1:17 PM.

## 144 11: Time, Appointments, and Date Arithmetic



## Appointments (APPT)

You can record up to ten appointments, each with an alarm. An appointment can contain a message. You can also create *repeating appointments*—appointments that recur at regular intervals.



### Viewing or Setting an Appointment (APT1-APT10)

**Table 11-3. Menu Labels for Setting Appointments**

Menu Label	Description
DATE	Sets the appointment date.
TIME	Sets the appointment time, <i>and</i> automatically enters the current date (if the existing appointment date was in the past).
A/PM	Sets AM or PM for 12-hour clock.
MSG	Displays the ALPHA menu and any existing message.
RPT	Displays the existing repeat interval and the menu for changing the repeat interval.
HELP	Displays the format for entering the date and time.

## To set an appointment or view its current setting:

1. Press **TIME**, then **APPT**. The display tells you which appointments (numbered 1-10) are *set* and which are *past due* (expired with unacknowledged alarms).

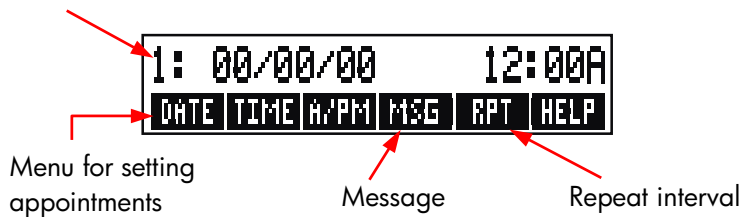


DUE:5 SET:2,3  
APT1 APT2 APT3 APT4 APT5 MORE

Pressing **MORE** displays the status and menu labels for appointments 6 through 10.

2. Press a menu key — **APT1** through **APT10**. The display shows the current appointment, if any, and the menu labels for setting appointments.
3. Optional: press **CLR DATA** to remove any old information.

Appointment number



1: 00/00/00 12:00A  
DATE TIME A/PM MSG APT HELP

Menu for setting appointments      Message      Repeat interval

4. **Setting the appointment time:** Use 12-hour or 24-hour time, as appropriate. Key in the time as a number in the form *HH.MM*. For example, 2:25 p.m. would be 2.25 (12-hour format) or 14.25 (24-hour format). Press **TIME**. *The date is automatically set to the current date if the existing date is in the past or was cleared.*

For 12-hour format: press **A/PM** to switch between AM and PM.

5. **Setting the appointment date:** Key in the date in the current date format. For example, enter October 4, 2003 as 10.042003 (month/day/year format) or 4.102003 (day.month.year format). Press **DATE**. *If the appointment is within a year from today, you can omit the year.*

6. **The appointment message (optional):** To set, change, or just view a

## 146 11: Time, Appointments, and Date Arithmetic

message, press **MSG**. Type the message (refer to page 30 for using the ALPHA menu). Messages are limited to a maximum of 22 characters. Press **INPUT** when done. (Press **EXIT** to negate any changes and retain the original message.)

- 7. The repeat interval (optional):** To set, view, or change a repeat interval, press **RPT**. Key in an integer and press the appropriate key. For example, 2 **DAY** causes the appointment to go off at the same time every other day; 90 **MIN** sets the repeat interval to 1½ hours. **NONE** sets the appointment to non-repeating. You can specify repeat intervals up to 104 weeks in length (728 days, 17,472 hours, etc.)
- 8.** When done, press **EXIT** to return to the APPT menu. The appointment you just set will be recorded, such as **SET:1**. You can check an appointment by pressing its menu key (such as **RPT1**).

**CLR** restores an appointment's time and date to the display if it has been overwritten by other operations.

## Acknowledging an Appointment

To acknowledge the appointment and clear the message, press any key (except **OFF**) during the beeping. Appointments not acknowledged within 20 seconds become past due.

When an appointment "comes due," the alarm starts beeping and the alarm annunciator ((●)) is displayed, even if the calculator was off.\*† The message (or, if none, the time and date) is displayed.

\* If the calculator is in the middle of a complex calculation when an appointment comes due, the alarm annunciator comes on and the calculator beeps once. When the calculation is done, the alarm goes off.

† The beeping can be suppressed or restricted to appointments. See "Beeper On and Off," page 36.

## Unacknowledged Appointments

An appointment not acknowledged during its alarm becomes past due. The alarm annunciator remains on.

### To acknowledge a past-due appointment:

1. Press **TIME** **APPT** .
2. Press the menu key for the past-due appointment.
3. Press **EXIT** to return to the APPT menu. The acknowledged appointment is no longer listed as past due.

A repeating appointment is deactivated while it is past due and will not go off subsequently until the past-due appointment has been acknowledged.

## Clearing Appointments

To cancel an appointment or to get rid of a repeating appointment, you need to *clear* the appointment. Clearing changes the date and time to 00/00/00, 12:00 AM, and removes the message and the repeat interval.

To clear an appointment, press the menu label for that appointment and press **CLR DATA**.

To clear all ten appointments, display the APPT menu (the menu with **APT1** , **APT2** etc.) and press **CLR DATA** **YES** .

**Example: Clearing and Setting an Appointment.** Today is Sunday, April 20, 2003. You want to set appointment #4 to go off every Tuesday at 2:15 p.m. to remind you of a staff meeting. Assume 12-hour time format and month/day/year date format.

### Keys:

**TIME** **APPT**

### Display:

### Description:

Displays setting for

## 148 11: Time, Appointments, and Date Arithmetic

<b>RPT4</b>		appointment #4.
<input type="checkbox"/> <b>CLR DATA</b>	4: 00/00/00 12:00A	Clears appt. #4.
2.15 <b>TIME</b>	4: SUN 04/20/03 2:15A	Stores appt. time <i>and</i> supplies current date.
<b>P/PM</b>	4: SUN 04/20/03 2:15P	Sets appt. time to PM.
4.22 <b>DATE</b>	4: TUE 04/22/03 2:15P	Stores appt. date.
<b>MSG</b>		Enters message: "staff".
<b>STAFF</b> <input type="text" value="INPUT"/>	4: TUE 04/22/03 2:15P	
<b>RPT</b>	RPT=NONE	Displays RPT menu.
1 <b>WEEK</b>	RPT=1 WEEK(S) 4: TUE 04/22/03 2:15P	Sets repeat interval.
<input type="text" value="EXIT"/>	SET: 4	Returns to APPT menu Appt. 4 is "set."

---

## Date Arithmetic (CALC)

The CALC menu performs date arithmetic:


- Determines the day of the week for any date.
- Determines the number of days between dates using one of three calendars—actual, 365-day, or 360-day.
- Adds or subtracts days from a date to determine a new date.


The calendar for date arithmetic runs from October 15, 1582 to December 31, 9999.

To display the CALC menu, press **TIME** , then **CALC** .

**Table 11-4. CALC Menu Labels for Date Arithmetic**

<b>Menu Label</b>	<b>Description</b>
<b>DATE1</b> <b>DATE2</b>	Stores or calculates a date. Also displays the day of the week. If you omit the year, the calculator uses the current year.
<b>DAYS</b>	Stores or calculates the number of <i>actual</i> days between <i>DATE1</i> and <i>DATE2</i> , recognizing leap years.
<b>360D</b>	Calculates the number of days between <i>DATE1</i> and <i>DATE2</i> using the 360-day calendar (30-day months).
<b>365D</b>	Calculates the number of days between <i>DATE1</i> and <i>DATE2</i> , using the 365-day calendar, ignoring leap years.
<b>TODAY</b>	A shortcut: recalls the current date, which can then be stored in <i>DATE1</i> or <i>DATE2</i> .

The calculator retains the values for the TIME CALC variables *DATE1*, *DATE2*, *DAYS* until you clear them by pressing  while the CALC menu is displayed.

To see what value is currently stored in a variable, press  menu label.

### **Determining the Day of the Week for Any Date**

To find the day of the week for any date, key in the date and press **DATE1** or **DATE2** .

### **Calculating the Number of Days between Dates**

To calculate the number of days between two dates:

1. Key in the first date (for today's date, use **TODAY** ) and press **DATE1** .

## **150 11: Time, Appointments, and Date Arithmetic**

2. Key in the second date and press **DATE2** .
3. Press **DAYS** , **360D** , or **365D** to calculate the number of days using that calendar.

**Example: Calculating the Number of Days between Two Dates.** Find the number of days between April 20, 2003 and August 2, 2040, using both the actual calendar and the 365-day calendar. Assume the date format is month/day/year.

<b>Keys:</b>	<b>Display:</b>	<b>Description:</b>
<b>TIME</b> <b>CALC</b>		Displays CALC menu.
4.202003		Stores Apr. 20, 2003 as first date and displays its day of the week.
<b>DATE1</b>	DATE1= 04/20/2003 SUN	
8.022040		Stores Aug. 2, 2040 as second date.
<b>DATE2</b>	DATE2 =08/02/2040 THU	
<b>DAYS</b>	ACTUAL DAYS= 13,619.00	Calculates actual number of intervening days.
<b>365D</b>	365 DAYS=13,609.00	Calculates number of intervening days by a 365-day calendar.

## Calculating Past or Future Dates

To calculate a date a specified number of days from another date:

1. Key in the known date (for today's date, use **TODAY** ) and press **DATE1** .
2. Key in the number of days. This number should be negative if the unknown date precedes the known date. Press **DAYS** .

## 11: Time, Appointments, and Date Arithmetic 151

3. Press **DATE2**.

This calculation always uses the actual calendar.

**Example: Determining a Future Date.** On February 9, 2003, you purchase a 120-day option on a piece of land. Determine the expiration date. Assume the date format is month/day/year.

**Keys:**

**TIME** **CALC**

2.092003

**DATE1**

120 **DAYS**

**DATE2**

**Display:**

DATE1=  
02/09/2003 SUN

ACTUAL  
DAYS=120.00

DATE2=  
06/09/2003 MON

**Description:**

Displays CALC menu.  
Stores Feb. 9, 2003.

Stores number of days into  
the future.

Calculates expiration date  
(DATE2).

## 152 11: Time, Appointments, and Date Arithmetic



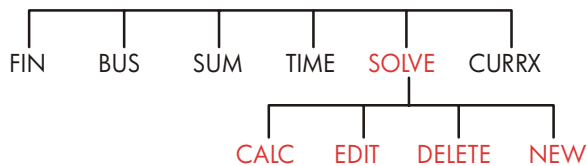
# 12

## The Equation Solver

---

The Equation Solver (the SOLVE menu) stores equations that you enter and creates menus for them. You can then use those menus to do calculations. Enter Solver equations in algebraic form regardless of the calculation mode (ALG or RPN).

The Solver can store many equations—the number and length of equations is limited only by the amount of memory available. The equations are stored in a *list*.



---

### Solver Example: Sales Forecasts

Suppose part of your job includes making sales forecasts, and that these forecasts are revised based on new information. For instance,

- A change in the price of the product will affect sales by a forecasted percentage, *A*%.
- A change in sales-force training will affect sales by a forecasted percentage, *B*%.
- A competitor's new product will affect sales by a forecasted percentage, *C*%.

Regardless of how you do this calculation (even if you do it longhand), you are using an equation:

$$\begin{aligned} \text{Next Forecast} &= \text{Old Forecast} + \text{Change in Old Forecast} \\ &= \text{Old Forecast} + (\text{Projected Percentage Changes} \\ &\quad \times \text{Old Forecast}) \end{aligned}$$

or:

$$\text{NEXT} = \text{OLD} + ((\text{A}\% + \text{B}\% + \text{C}\%) \div 100 \times \text{OLD})$$

Using the SOLVE and ALPHAbetic menus, you can type in this equation as

$$\text{NEXT}=\text{OLD}+(\text{A}\%+\text{B}\%+\text{C}\%)\div 100\times\text{OLD}$$

and then automatically create this menu—which contains all the variables' labels—by pressing   :\*



Each menu label represents a *variable*. You can use them to store and calculate values the same way you use other menus and their built-in variables.

**Entering a Solver Equation.** To type this equation, you must use the ALPHA menu. If you are not familiar with the ALPHAbetic menu, refer to “Typing Words and Characters ” on page 30.

**Keys:**

NEXT  OLD

**Display:**

TYPE EQUATION;  
[INPUT]

**Description:**

Displays SOLVE menu, then ALPHA menu.

The equation is too long

\* Because the Solver uses arithmetic priority ( $\times$ ,  $\div$  before  $+$ ,  $-$ ), a second set of parentheses (before A% and after the second OLD) is not necessary. See “Order of Calculations,” page 165.

**154 12: The Equation Solver**

**[+]** **[C]** A **[%]** **[+]**

B **[%]** **[+]** C **[%]**

**[)]** **[÷]** 100 **[X]**

OLD                    ...D+(A%+B%+C%)  
                         ÷100×OLD

**[INPUT]**

NEXT=OLD+  
(A%+B%+C%)÷1...

for the display.

Enters equation into list.

**[EDIT]**

**[-->>]**

**[-->>]**

...D+(A%+B%+C%)  
÷100×OLD

Controls view of full equation.

**[EXIT]**

NEXT=OLD+  
(A%+B%+C%)÷1...

Displays SOLVE menu.

**Calculating with the Solver.** Suppose last month's forecast for a product was 2,000 units. In the meantime, three market changes have occurred that affect this forecast. A) The price of the product has dropped, causing an expected 20% increase in sales. B) A major sales-force training program started, causing an expected 5% increase in sales. C) A competitor is introducing a new product, causing an expected 15% drop in sales. Calculate the new forecast for next month.

**Menu Label:**

**Display:**

**Description:**

**[CALC]**

VERIFYING  
EQUATION

Verifies that equation is valid; creates Solver menu with menu labels for this equation.

2000 **[OLD]**

OLD=2,000.00

Stores old forecast.

20 **[A%]**

A%=20.00

Stores effect of price drop on sales.

5 **[B%]**

B%=5.00

Stores effect of sales-force training on sales.

**12: The Equation Solver 155**

15 **C%** C%=-15.00

Stores effect of competitor's new product on sales.

**NEXT** NEXT=2,200.00

Calculates new forecast for next month.

Suppose your boss wants next month's forecast to be 2,300 units. You can't affect *A%* or *C%*, but you can affect *B%* through the sales training program. Determine what *B%* must be for *NEXT* to equal 2,300 units. All you need to do is re-enter the one value you are changing:

**Keys:**

2300 **NEXT**

**B%**

**Display:**

NEXT=2,300.00

B%=10.00

**Description:**

The training program would need to result in a 10% increase in sales to effect a new forecast of 2,300.

---

## The SOLVE Menu

If the Solver list is empty, you will see an instruction for entering an equation when you press **SOLVE** :

```
(NEW) FOR NEW EQUATION
CALC EDIT DELET NEW
```

If the Solver list is not empty, you will see the *current equation*—the last one entered or selected.

Pressing , , , , and moves you through the list.

## 156 12: The Equation Solver

**Table 12-1. The SOLVE Menu Labels**

<b>Menu Label</b>	<b>Description</b>
<b>CALC</b>	Verifies the current equation and creates menu labels for it. This is necessary before doing any calculations.
<b>EDIT</b>	Accesses the ALPHA-Edit menu (page 31) so you can alter the current equation. The arrow keys move long equations across the display.
<b>DELET</b>	Deletes the current equation or just its variables (that is, the space allotted in memory for the variables).
<b>NEW</b>	Allows you to enter a new equation.

While you're working with a specific equation in the Solver, the equation's own menu appears in the display. To retrieve the primary SOLVE menu, press **EXIT**.

---

## Entering Equations

### To make an entry into the Solver list:

1. Press **SOLVE** **NEW**. (To insert the new entry at the bottom of the list, press **▣** **▼**.)
2. Use the ALPHA menu to type in characters (see page 30), and use the regular keyboard to type in digits and arithmetic operators (+, =,  $y^x$ , etc.). If you make a mistake, use **⬅** to backspace or **CLR** to start over. Or press **EXIT** to bring up the ALPHA-Edit menu.
3. Press **INPUT** to store the equation.
4. Press **CALC** to verify that the equation is valid, and to create its menu labels. You now can proceed with your calculations.

When you press **CALC** the calculator displays:

VERIFYING EQUATION...

while the Solver checks that the equation is mathematically valid. (However, the Solver has no way of checking whether the equation is the right one for *your* problem.) If the equation cannot be solved, the calculator briefly displays:

INVALID EQUATION

and the cursor will blink at the first character that the Solver could not interpret. (It is possible that your mistake is somewhere else, but this is a good place to start looking, since this is where the Solver got stuck.) The ALPHA-Edit menu appears so you can make changes.

Check to be sure you've made no typing mistakes, and that you've followed the rules for writing equations given on page 166 under "What Can Appear in an Equation."

An entry that is not an equation will be stored when you press **INPUT** , but it cannot be verified when you press **CALC** .

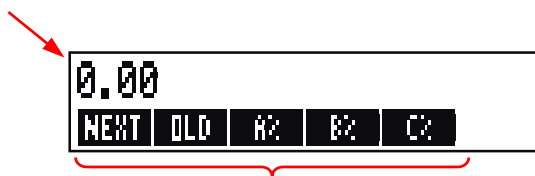
---

## Calculating Using Solver Menus (CALC)

If pressing **CALC** creates a Solver menu for your equation, then the equation is good (that is, mathematically valid).

If the equation contains more than six variables, the Solver uses the label **MORE** to switch between sets of menu labels.

Calculator line



Solver menu

To test whether your equation is in fact correct, test it out by entering some values for which you already know the result, and see if the Solver's result is correct.

**To do a calculation using a Solver menu:**

## 158 12: The Equation Solver

1. Store values in all but one of the variables (for example, 2000 `OLD`, etc.). Remember that you can verify stored values by pressing `RCL` menu label.
2. To start the calculation, press the menu key for the variable you want to calculate.

In most cases, this is all you need to know about how the Solver works. However, certain types of equations are more difficult to solve. If, during the calculation, the display temporarily shows two lines of changing numbers, such as

```
A:1.500000000000 -
A:1.13476129834 +
```

then the Solver is searching for a result for the variable A. Read the section, "How the Solver Works," starting on page 179.

**Example: Return on Equity.** The Return on Equity of a business can be defined as:

$$\text{ROE} = \frac{\text{Operating income} - \text{Interest} - \text{Taxes}}{\text{Common equity}}$$

Find the ROE of a small firm with \$2,000 in assets. The assets earned 10% while its debt cost it 8%. The assets were financed using \$500 of common equity and \$1,500 of debt. The firm paid no taxes.

$$\begin{aligned} \text{Operating income} &= \text{assets} \times \text{percentage earnings on assets} \\ &= \text{ASSET} \times \% \text{ERN} \end{aligned}$$

$$\begin{aligned} \text{Interest} &= \text{debt} \times \text{percentage interest paid on debt} \\ &= \text{DEBT} \times \% \text{INT} \end{aligned}$$

$$\begin{aligned} \text{Common equity} &= \text{amount of common equity used for financing} \\ &= \text{EQTY} \end{aligned}$$

The Solver equation would be:

$$\text{ROE} = (\text{ASSET} \times \% \text{ERN} \div 100 - \text{DEBT} \times \% \text{INT} \div 100 - \text{TAX}) \div \text{EQTY} \times 100$$

**Keys:**

 **MAIN**

 **SOLVE**  **NEW**

**ROE** 

 **ASSET** 

 **ERN**

 **DEBT** 

 **INT**

 **TAX** 

 **EQTY**

 **INPUT**

 **CALC**

2000  **ASSET**

10  **ERN**

1500  **DEBT**

8  **INT**

 **MORE** 0

 **TAX**

500  **EQTY**

 **MORE**

 **ROE**

**Display:**

TYPE EQUATION:  
[ INPUT ]

...-DEBTx%INT-TAX)  
÷EQTY

ROE=(ASSETx%ERN  
-DEBTx...

ASSET=2,000.00

%ERN=10.00

DEBT=1,500.00

%INT=8.00

TAX=0.00

EQTY=500.00

ROE=16.00

**Description:**

Restores MAIN menu.

Displays ALPHA menu.

Entering the equation.

Stores the equation.

Verifies the equation and displays the menu labels for *ROE*, *ASSET*, *%ERN*, *DEBT*, *%INT*, and (press **MORE**) *TAX* and *EQTY*.

Stores the values for the assets, the percentage earnings on assets, the amount of debt, the percentage interest paid on the debt, the taxes paid, and the common equity.

The return on equity is 16%.

**160 12: The Equation Solver**



---

## Editing an Equation (EDIT)

If you have an `INVALID EQUATION`, the cursor stops over the first character that the Solver could not logically interpret.

You can alter the current equation using the ALPHA-Edit menu:

1. Press `EDIT` to access the ALPHA-Edit menu. (See “Editing ALPHAbetic Text,” page 31.) You can use `◀` (backspace) and `CLR` (clear), as well.
2. To *insert* letters, press `ALPHA` and the appropriate letters. Press `EXIT` to bring back the editing menu.
3. Press `INPUT` to replace the previous version with the edited version.

Editing an equation clears its variables.

To abort an editing operation without saving any of the changes, press `EXIT`.

---

## Naming an Equation

Naming equations helps you identify them later. The name precedes the equation, separated by a colon. If you don't name an equation initially, you can name it later using `EDIT`.



```
FORE: NEXT=OLD+(A%+B%+...
CALC EDIT DELET NEW
```

Type the name just as you type the rest of the equation. The calculator knows that whatever comes before the colon is not part of the equation. The name is for your visual aid only; the calculator cannot recognize it.

Names can be any length and contain any character except `+ - x ÷ ( ) < > ^ : = space`

---

## Finding an Equation in the Solver List

To display an entry in the Solver list, display the SOLVE menu and move through the list using the  $\blacktriangle$  and  $\blacktriangledown$  keys.  $\blacksquare\blacktriangle$  moves to <TOP OF LIST> and  $\blacksquare\blacktriangledown$  moves to <BOTTOM OF LIST>.

---

## Shared Variables

If two or more equations contain the same variable, that variable is *shared* among those equations. For example, suppose your Solver list of equations includes these two equations labeled RUG, which figures the cost of a carpet, and TOTAL, which figures the total cost of buying a carpet and installing it:

$$\text{RUG: } P/YD \times L \times W \div 9 = \text{COST}$$

$$\text{TOTAL: } \text{COST} + \text{HOURS} \times 20.50 = \text{CHARGE}$$

*COST* is a shared variable. You can calculate a value for *COST* using the RUG equation, then switch to the TOTAL equation and calculate *CHARGE* after entering *HOURS*. Since the value for *COST* is shared, you do not need to store it again.

No sharing occurs between variables outside the Solver and those within the Solver. For example, this *COST* variable in the Solver is not shared with the *COST* variable in the MU%C and MU%P menus in BUS.

To transfer values between built-in variables and Solver variables, store them into storage registers. Recall them after switching menus. Remember that the value in the calculator line stays there when you switch menus.

---

## Clearing Variables

You can clear the variables in a Solver equation just as you clear variables in other menus: press  $\blacksquare\text{CLR DATA}$  while the menu with those variables is displayed.



Make sure that the *menu for the variables* is in the display. (The equation itself should *not* be in the display. If it is, press **CALC**.) Pressing **CLR DATA** now sets *NEXT*; *OLD*, *A%*, *B%*, and *C%* to zero.

Variables are also cleared when their equation is edited.



**Note**

If the SOLVE menu is displayed (rather than the SOLVE CALC menu), then pressing **CLR DATA** will prompt **DELETE ALL VARIABLES?**. Press **NO**, otherwise you will lose the variables in all the equations. (See “Deleting All Equations or Variables in the Solver,” page 164.)

## Deleting Variables and Equations

Each equation in the Solver list uses calculator memory to store 1) itself, and 2) its variables.\*

*Deleting a variable* is quite different from *clearing* it:

- *Clearing* a variable sets it to zero; the variable retains its storage location in memory. This does not save memory space.
- *Deleting* a variable erases its value *and* its storage location. This is a way to save memory space. If a variable is shared, its value is lost to all equations that share it. The memory space for a deleted variable is re-created the next time you use that equation.

\* An equation that has not been verified (**CALC** pressed) does not have any variables allocated to it. Therefore, it has no variables to be cleared or deleted.

## Deleting One Equation or Its Variables (DELET)

To delete an equation or its variables:

1. Display the equation.
2. Press **DELET** in the SOLVE menu.
3. To delete the equation, respond **YES** to both questions:  
DELETED THE VARIABLES?  
DELETED THE EQUATION?  
(If the entry has no variables allocated, then only the second question appears.)
4. To delete just the variables, respond **NO** to  
DELETED THE EQUATION?. This preserves the equation.

## Deleting All Equations or All Variables in the Solver

### (**CLR DATA**)

To delete *all* the equations in the Solver, or just all the variables in all the equations:

1. Display the SOLVE menu. It doesn't matter which equation is displayed.
2. Press **CLR DATA**. To delete all equations, respond **YES** to both questions:  
DELETE ALL VARIABLES?  
DELETE ALL EQUATIONS?
3. To delete just the variables, respond **NO** to  
DELETE ALL EQUATIONS?. This preserves all equations.

---

## Writing Equations

An equation in a book looks different from an equation in the Solver. A numerator and denominator might be separated by a bar, such as

$$\frac{a+b+c}{d-e \times f}$$

Since a Solver equation appears all on one line, you must group the numerator and denominator separately by using *parentheses*, such as

$$(A+B+C) \div (D-E \times F)$$

**Order of Calculations.** Operations occur from left to right *but* do:

- **Exponentiation first.** For example,  $A \times B^3 = C$  is interpreted as  $A \times B^3 = C$ .  $B$  is raised to the 3rd power and *then* multiplied by  $A$ . To raise  $A \times B$  to the 3rd power, write the equation as  $(A \times B)^3 = C$ .
- **Multiplication and division before addition and subtraction.** For example,  $A+B \div C = 12$  is interpreted as  $A + (B/C) = 12$ . To divide the sum of  $A + B$  by  $C$ , enter the equation as  $(A+B) \div C = 12$ .

**Parentheses.** Parentheses override the above rules of priority. *When in doubt, use parentheses.* It never hurts to use parentheses—even multiple parentheses. (Do not use brackets or braces.)

For example, earlier (page 154) we used the equation

$$\text{Next Forecast} = \text{Old Forecast} + \left( \frac{(A\% + B\% + C\%) \times \text{Old Forecast}}{100} \right),$$

which was entered into the calculator as

$$\text{NEXT} = \text{OLD} + (A\% + B\% + C\%) \div 100 \times \text{OLD}.$$

$$\frac{A}{B \times C} \text{ would be entered as } A \div (B \times C).$$

$$A + \frac{B \times C}{D \times E} \text{ could be entered as } A + B \times C \div (D \times E).$$

$A + \frac{B \times C}{(D+5) \times E}$  could be entered as `A+BxC÷((D+5)xE)`.

---

## What Can Appear in an Equation

**Long Equations.** There is no limit on the length of an equation (or the number of variables it has) if there is enough memory to store it. An equation longer than one display line (22 characters) moves to the left and adds an ellipsis (...).

To view a long equation, move the cursor using the arrow keys on the ALPHA-Edit menu. For example:

```
TOTALCOST=LENGTH×WIDTH×HEIGHT÷12×UNIT×(1+MARKUP%÷100)
```

looks like

```
TOTALCOST=LENGTH×WIDT...
```

when it is stored. Press **EDIT** **→>** **→>** to view successive portions of the equation:

```
...H×HEIGHT÷12×UNIT×(1+...
```

**Spaces.** You can use as many spaces as you like *between* variables, operators, and numbers.

**Names of Variables.** A variable's name can be up to 10 characters long, but cannot contain the characters `+ - × ÷ ^ ( ) < > = :` *space*

The first three to five characters (depending on their widths) become the variable's menu label. Therefore, make sure no two variables in the same equation have the same first three to five characters.

Do not use AND, NOT, OR, XOR, or PI as variable names because they will be interpreted as functions.

**Numbers (Constants).** Do not put commas or other characters in numbers. For instance, type `10000` for ten thousand (*not* `$10,000`).

## 166 12: The Equation Solver

**Parentheses.** Do not use brackets or braces. Parentheses determine order, but do *not* imply multiplication. For example, the equation  $P_{sn} = P_s(1 - F)$  would be typed into the Solver as  $P_{SN}=P_S \times (1 - F)$ . The  $\times$  sign must be inserted between  $P_S$  and the parenthesis.

**Functions and Conditional Expressions.** An equation can contain any of the functions and conditional expressions given in the table on pages 168-171. Some of these functions also have *typing aids*.

**Math Operators (“Typing Aids”).** All of the math operators are located either on the keyboard ( $\div$ ,  $\frac{1}{x}$ , etc.) or in the MATH menu (LN, EXP, etc.). Any of these operators *except* % can be included in an equation. (In the Solver, % is just a character.) You can call up the MATH menu from the Solver.

Many of these operators look different in an equation: pressing  $\sqrt{x}$  produces  $\sqrt{\phantom{x}}$ , for example. You then supply a number or variable followed by a closing parenthesis. The list of Solver functions on pages 168-171 shows the spelling of each function. Note that you supply the number *after* supplying the function.

You can also type these functions letter by letter using the ALPHA menu. However, it is faster to select math operators directly on the keyboard or in the MATH menu. This is called a *typing aid*.

For instance, these two methods of placing 25! (factorial) into an equation are equivalent. Starting after SOLVE NEW :

### 1. Using the ALPHA Menu

Keys:	Display:	Description:
FGHI		
F	F	
ABCDE		
A	FA	

ABCDE	
C	FAC
RSTUV	
T	FACT
( 25 ) =	FACT(25)=
ABCDE	
A	FACT(25)=A

This calculates 25!  
(factorial).

## 2. Using a Typing Aid



### Keys:

 MATH

### Display:

 N!      FACT<

25        FACT(25)=

 ABCDE  
 A      FACT(25)=A

### Description:

MATH menu labels appear.

The ALPHA menu automatically returns after one MATH selection.

This also calculates 25!, and with fewer keystrokes.

---

## Solver Functions

Here is a complete list of functions that you can include in Solver equations. The items inside parentheses must be replaced by specific numbers, variables, or algebraic expressions.

In addition, you can use the arithmetic operators (+, −, ×, ÷,  $y^x$ ), *but not*  $\%$ . (In the Solver,  $\%$  is just a character, not an operator.)

## 168 12: The Equation Solver



**Table 12-2. Solver Functions for Equations**

Function	Description
ABS( <i>x</i> )	Absolute value of <i>x</i> .
ALOG( <i>x</i> )	Common (base 10) antilogarithm; $10^x$ .
CDATE	Current date.
CTIME	Current time.
DATE( <i>d1</i> : <i>n</i> )	The date <i>n</i> days after (when <i>n</i> is positive) or before (when <i>n</i> is negative) date <i>d1</i> . The format for <i>d1</i> is set in the TIME/SET menu.
DDAYS( <i>d1</i> : <i>d2</i> : <i>cal</i> )	<p>Number of days between dates <i>d1</i> and <i>d2</i>. Formats for <i>d1</i> and <i>d2</i> are set in the TIME menu; <i>cal</i> designates the calendar:</p> <ul style="list-style-type: none"> <li>■ <i>cal</i> = 1 for the actual calendar, which recognizes leap years.</li> <li>■ <i>cal</i> = 2 for the 365-day calendar, which ignores leap years.</li> <li>■ <i>cal</i> = 3 for the 360-day calendar, which uses 12, 30-day months.</li> </ul>
EXP( <i>x</i> )	Natural antilogarithm; $e^x$ .
EXPM1( <i>x</i> )	$e^x - 1$ .
FACT( <i>x</i> )	<i>x</i> !; factorial of a positive integer.
FLOW(CFLO-listname:flow#)	Value of the specified cash flow.
FP( <i>x</i> )	Fractional part of <i>x</i> .

**Table 12-2. Solver Functions for Equations (Continued)**

<b>Function</b>	<b>Description</b>
HMS( <i>time</i> )	Converts time in decimal hours to <i>HH.MMSS</i> format.
HRS( <i>time</i> )	Converts time in <i>HH.MMSS</i> format to decimal hours.
IDIV( <i>x</i> : <i>y</i> )	Integer part of the quotient of <i>x</i> / <i>y</i> .
IF( <i>cond</i> : <i>expr</i> <sub>1</sub> : <i>expr</i> <sub>2</sub> )	Conditional expression: if <i>cond</i> is true, use <i>expr</i> <sub>1</sub> ; if <i>cond</i> is false, use <i>expr</i> <sub>2</sub> . See page 174.
INT( <i>x</i> )	Greatest integer less than or equal to <i>x</i> .
INV( <i>x</i> )	Inverse of <i>x</i> ; 1/ <i>x</i> .
IP( <i>x</i> )	Integer part of <i>x</i> .
ITEM( <i>SUM-listname</i> : <i>item</i> #)	Value of the specified <i>SUM-list</i> item.
LN( <i>x</i> )	Natural (base <i>e</i> ) log of <i>x</i> .
LNP1( <i>x</i> )	ln (1 + <i>x</i> )
LOG( <i>x</i> )	Common (base 10) log of <i>x</i> .
MAX( <i>x</i> : <i>y</i> )	Compares <i>x</i> and <i>y</i> , and returns the larger of the two.
MIN( <i>x</i> : <i>y</i> )	Compares <i>x</i> and <i>y</i> , and returns the smaller of the two.
MOD( <i>x</i> : <i>y</i> )	Remainder of the division <i>x</i> / <i>y</i> . MOD( <i>x</i> , <i>y</i> ) = <i>x</i> - <i>y</i> × INT( <i>x</i> / <i>y</i> )
PI	π ; 3.14159265359 (12 digits).
RND( <i>x</i> : <i>y</i> )	Rounds <i>x</i> to <i>y</i> decimal places if 0 ≤ <i>y</i> ≤ 11, or rounds <i>x</i> to <i>y</i> significant digits if -12 ≤ <i>y</i> ≤ -1. <i>y</i> must be an integer.
S( <i>variable name</i> )	Used in an IF function to test if <i>solving for</i> the variable named. Used to combine related equations into one Solver menu. See page 178.
SGN( <i>x</i> )	Sign of <i>x</i> (+1 if <i>x</i> > 0, 0 if <i>x</i> =0, -1 if <i>x</i> < 0.

**Table 12-2. Solver Functions for Equations (Continued)**

Function	Description
$\Sigma(\text{cfr};c_1:c_2:s:\text{expr})$	Summation of the algebraic expression <i>expr</i> for values of the counter <i>ctr</i> , stepping from $c_1$ to $c_2$ at increments of <i>s</i> . See page 176.
SIZEC( <i>CFLO-listname</i> )	The number of the last flow in specified CFLO list.
SIZES( <i>SUM-listname</i> )	The number of items in specified SUM list.
SPFV( <i>i%:n</i> )	Future value of a single \$1.00 payment; equivalent to $(1 + i\% \div 100)^n$ . <i>n</i> is the number of compounding periods. <i>i%</i> is the interest rate per compounding period, expressed as a percentage.
SPPV( <i>i%:n</i> )	Present value of a single \$1.00 payment; equivalent to $1 \div \text{SPFV}(i\%:n)$ . <i>n</i> is the number of compounding periods. <i>i%</i> is the interest rate per compounding period, expressed as a percentage.
SQ( <i>x</i> )	Square of <i>x</i> ; $x^2$ .
SQRT( <i>x</i> )	Square root of <i>x</i> ; $\sqrt{x}$ .
#T( <i>CFLO-listname:flow#</i> )	The number of times that specified cash flow occurs.
TRN( <i>x:y</i> )	Truncates <i>x</i> to <i>y</i> decimal places if $0 \leq y \leq 11$ , or truncates <i>x</i> to <i>y</i> significant digits if $-12 \leq y \leq -1$ . <i>y</i> must be an integer.
USFV( <i>i%:n</i> )	Future value of a uniform series of \$1.00 payments; equivalent to $(\text{SPFV}(i\%:n) - 1) \div (i\% \div 100)$ . <i>n</i> is number of payments. <i>i%</i> is periodic interest rate, expressed as a percentage.
USPV( <i>i%:n</i> )	Present value of a uniform series of \$1.00 payments; equivalent to $\text{USFV}(i\%:n) \div \text{SPFV}(i\%:n)$ . <i>n</i> is number of payments. <i>i%</i> is periodic interest rate, expressed as a percentage.

**Example Using a Solver Function (USPV): Calculations for a Loan with an Odd First Period.** Suppose an auto purchase is financed with a \$6,000 loan at 13.5% annual interest. There are 36 monthly payments starting in one month and five days. What is the payment amount?

Use the following formula when the time until the first payment is more than one month but less than two months. Interest for this odd (non-integer) period is calculated by multiplying the monthly interest by the number of days and dividing by 30.

The formula for this loan is:

$$PV \left( 1 + \frac{ANNI}{1200} \times \frac{DAYS}{30} \right) + PMT \left( \frac{1 - \left( 1 + \frac{ANNI}{1200} \right)^{-N}}{\frac{ANNI}{1200}} \right) = 0$$

where:

*ANNI* = the annual percentage interest rate.

*N* = the number of payment periods.

*DAYS* = the number of leftover, odd days (an integer from 0 through 30).

*PV* = the amount of the loan.

*PMT* = the monthly payment.

The formula can be rearranged and simplified using USPV, the Solver function for returning the present value of a uniform series of payments:

$$PV \times \left( 1 + \frac{ANNI}{1200} \times \frac{DAYS}{30} \right) + PMT \times USPV \left( \frac{ANNI}{12}; N \right) = 0$$

The keystrokes are:

PV  $\times$   $\left( 1 + \frac{ANNI}{1200} \times \frac{DAYS}{30} \right) + PMT \times USPV \left( \frac{ANNI}{12}; N \right) = 0$

## 172 12: The Equation Solver

**Keys:**SOLVE  

NEW

(type in  
equation as  
shown above)

INPUT

CALC

6000 PV

13.5 ANNI

5 DAYS

36 N

PMT

**Display:**

&lt;BOTTOM OF LIST&gt;

TYPE EQUATION:  
[INPUT]...MT×USPV<ANNI÷  
12:N>=0

0.00

PV=6,000.00

ANNI=13.50

DAYS=5.00

N=36.00

PMT=-203.99

**Description:**

Displays SOLVE menu and  
bottom of Solver list.

Displays ALPHA menu.

Remember that the colon is  
located after. OTHER

(Press    )

Enters equation, verifies  
it, and creates menu.

Stores loan amount in  
*PV*.

Stores annual percent interest  
in *ANNI*.

Stores number of odd days in  
*DAYS*.

Stores number of payments in  
*N*.

Calculates monthly *PMT* of  
\$203.99.

**12: The Equation Solver 173**

## Conditional Expressions with IF

Equations can include conditional expressions using the function IF. The syntax of the IF function is:

IF(*conditional expression* ; *algebraic expression* ; *algebraic expression*) \*

↑ *then*
↑ *or else*










For example, the solver accepts the equation:

BONUS=IF(SALES>3000;.02×SALES;.01×SALES)

According to this equation, if *SALES* is greater than 3000, then the *BONUS* equals  $.02 \times SALES$ ; otherwise (“or else”), *BONUS* equals  $.01 \times SALES$ .

**Logical Operators.** Four logical operators can be used in conditional expressions: AND, OR, XOR, and NOT.

**Relational Operators.** Six relational operators are available for conditional expressions.

Operator	Keys
>	 (ALPHA menu)
<	 (ALPHA menu)
=	
≥	 
≤	 
≠	 

\* A *conditional expression* that contains within it an algebraic expression might cause the error **INVALID EQUATION**. If this happens, insert a + before the left parenthesis starting the algebraic expression. For example, change  
 IF((R+2)+5<12;... to  
 IF+(R+2)+5<12;....

## 174 12: The Equation Solver

### Examples of Conditional Equations.

■  $B = \text{IF} (A > 7 \text{ AND } A \leq 15 : 2 \times A + 6 : 3 \times A + 10) + C$

Means: If A is greater than 7 and is less than or equal to 15, then  $B = 2 \times A + 6 + C$ . Otherwise,  $B = 3 \times A + 10 + C$ .

■  $\text{VALUE} = \text{FIRST} + \text{IF} (\text{NOT} (\text{FIRST} = 0) : 1 \div \text{FIRST} : 0)$

Means: If *FIRST* is not equal to 0, then

$\text{VALUE} = \text{FIRST} + 1 \div \text{FIRST}$ . If  $\text{FIRST} = 0$ , then  $\text{VALUE} = \text{FIRST}$ .

■  $T = W \times \text{IF} (A = 0 \text{ XOR } B = 0 : A + B : A \times B)$

Means: If A or B, but not both, equals 0, then  $T = W \times (A + B)$ .

Otherwise,  $T = W \times A \times B$ . In other words,

When  $A = 0$  and  $B \neq 0$ ,  $T = W \times B$ .

When  $A \neq 0$  and  $B = 0$ ,  $T = W \times A$

When  $A = 0$  and  $B = 0$ ,  $T = 0$ .

When  $A \neq 0$  and  $B \neq 0$ ,  $T = W \times A \times B$ .

**Example: Nested IF Functions.** An IF function can be used as the argument of another IF function. This is called *nesting*. Suppose a corporation uses a rating system to determine salary. Employees are rated on a scale from 1 through 3, and are given the following annual percent raise based on their rating:

Rating	Percent Salary Increase
1	3%
2	6%
3	10%

The Solver equation to calculate an employee's new salary is based on his or her rating and old salary. What would be the new annual salary for an employee with a rating of 2 who currently earns \$27,500 annually?

Press **SOLVE** **NEW**, then enter the equation:

$$\text{NEW} = \text{OLD} \times (1 + \text{IF}(R=1, .03, \text{IF}(R=2, .06, .1)))$$

To do the calculation:

<b>Keys:</b>	<b>Display:</b>	<b>Description:</b>
<b>INPUT</b>		Stores, verifies, and creates menu labels for the equation.
<b>CALC</b>		
27500 <b>OLD</b>	OLD=27,500.00	Stores old salary.
2 <b>R</b>	R=2.00	Stores rating.
<b>NEW</b>	NEW=29,150.00	Calculates new salary.

## The Summation Function ( $\Sigma$ )

The  $\Sigma$  function does summation calculations in an equation:

$\Sigma(\text{counter variable} ; \text{starting value} ; \text{ending value} ; \text{step size} ; \text{algebraic expression})$

The *counter variable* takes on a series of values, beginning with the *starting value*, and incrementing according to the *step size*, until it passes the *ending value*. For each value of the counter, the *algebraic expression* is evaluated, and the value is added to the previous value. The  $\Sigma$  function returns the final summation.

For example, when the equation:

$$\text{SERIES} = \Sigma(I : 1 : 6 : 1 : I \times X^I)$$

is solved for *SERIES*, the counter *I* runs from 1 through 6 in steps of one—that is, 1, 2, 3, 4, 5, 6. For each value *I*, the expression  $I \times X^I$  is

## 176 12: The Equation Solver



calculated and added to the sum. Thus the stored value of  $X$  is used to calculate  $X + 2X^2 + 3X^3 + 4X^4 + 5X^5 + 6X^6$ .

The following equation uses a variable as the ending value, 0 as the beginning value, and a step size of 2.

$$\text{SERIES}=\Sigma(\text{I}:0:\text{LAST}:2:\text{I}\times\text{X}^{\text{I}})$$

If 8 is stored in *LAST*, *I* takes on values of 0, 2, 4, 6, and 8. Then the stored value of  $X$  will calculate  $2X^2 + 4X^4 + 6X^6 + 8X^8$ .

## Accessing CFLO and SUM Lists from the Solver

You can use a Solver equation to perform calculations other than those in the CFLO and SUM menus using data stored in CFLO and SUM lists. The following Solver functions gain access to these lists.

- $\text{SIZEC}(\text{CFLO-listname})$  returns the number of the last flow in the specified CFLO list. For example, if the last flow in the list *INV* were  $\text{FLOW}(6)=5,000.00$ , then  $\text{SIZEC}(\text{INV})$  would equal 6.00.
- $\text{FLOW}(\text{CFLO-listname} : \text{flow number})$  returns the value of the specified flow.
- $\#\text{T}(\text{CFLO-listname} : \text{flow number})$  returns the number of times the specified flow occurs.
- $\text{SIZES}(\text{SUM-listname})$  returns the number of items in the specified SUM list.
- $\text{ITEM}(\text{SUM-listname} : \text{item number})$  returns the value of the specified item.

**Summation of List Data.** The  $\Sigma$  function can be used to sum calculations done with numbers in lists. For example, the following equation calculates  $\sum x_i^2 y_i^2$  for values stored in two SUM lists named *XVAR* and *YVAR*, which must have the same number of items:

$$\text{SX2Y2}=\Sigma(\text{I}:1:\text{SIZES}(\text{XVAR}):1:\text{ITEM}(\text{XVAR}:\text{I})^2\times\text{ITEM}(\text{YVAR}:\text{I})^2)$$

“Chi-Squared Statistics” in chapter 14 illustrates another use of the  $\Sigma$  function with SUM lists.

## Creating Menus for Multiple Equations (S Function)

The *S* (*solving for*) function is used in conjunction with the IF function to group related equations together and to specify the criteria for choosing one of them to solve.

$S(\text{variable name})$

The advantage over two separate equations is that the single equation gives you a single menu with all possible variables. That way, if you are working with two different but related problems, you can keep the same Solver menu labels in the display all the time—you don’t have to switch equations.

For example, consider these two equations for conversions:

$$KG \times 2.21 = LB \quad \text{and} \quad M \times 3.28 = FT$$

The following, rearranged single equation can do either conversion:

$$IF(S(KG) \text{ OR } S(LB) : KG \times 2.21 - LB : M \times 3.28 - FT) = 0$$

This means: if you are *solving for* either *KG* or *LB*, then use  $KG \times 2.21 - LB = 0$ . Otherwise (that is, if you are solving for *M* or *FT*), use  $M \times 3.28 - FT = 0$ . The two conversion equations are rewritten so that all the variables appear on one side of each equation, and the other side is set equal to zero.

The *S* function appears as part of the conditional expression of the IF function. You can leave out the “=0” and it will be understood that the whole equation is set equal to zero.

**Example: Unit Conversions.** Use the above equation to convert between kilograms and pounds and between meters and feet.

Press **SOLVE** **NEW** then enter the equation:

## 178 12: The Equation Solver

IF(S(KG) OR S(LB):KG×2.21-LB:M×3.28-FT)

Press **INPUT** to store it, then **CALC** to verify it and create its menu:



1. Convert 225 pounds to kilograms.  
Press 225 **LB** **KG** Result is **KG=101.81**.
2. How many feet equal 100 meters?  
Press 100 **M** **FT** Result is **FT=328.00**.

Note that you do not have to clear variables between steps 1 and 2. The S function considers only those values in the part of the equation that it is solving.

---

## How the Solver Works

The Solver has two ways of finding an answer. First, it tries to find a *direct* solution by rearranging the equation and then solving for the variable. If the Solver finds a direct solution, the calculator displays the result.

If the Solver is unable to find a direct solution, it tries to find the answer indirectly by *iteration*. It estimates a set of answers, sees how close they are to a solution, and then makes another set of estimates. The calculator displays the Solver's current estimates as the Solver searches for an answer. You should keep in mind that *there might be more than one solution to an equation*, and that it might be necessary for you to enter guesses to influence which solution the Solver finds. If the displayed estimates don't appear to be proceeding towards a number you judge to be a reasonable answer, you can stop this iterative process, enter your own guesses, and restart the search. (See "Halting and Restarting the Iterative Search" and "Entering Guesses," below.)

The process of finding a solution iteratively is very complex. There are four possible outcomes. Refer to “Solver Calculations” in appendix B for additional descriptions of these outcomes.

- **Case 1:** The calculator displays a result. It is very likely that this is a solution to the equation. To check how good this result is, you can repeat the calculation by pressing the menu key for the variable you solved for. If the two sides of the equation have not been calculated to be exactly equal, the calculator displays a message with the values for the left and right sides of the equation. Read “Solver Calculations” in appendix B for an explanation of the meaning of this display.
- **Case 2:** The calculator displays a message with the calculated, unequal values of the left and right sides of the equation. The Solver has found a possible solution, but you must interpret its validity. To see the questionable solution, press  $\blacktriangleleft$  or  $\boxed{\text{CLR}}$ . Refer to “Solver Calculations” in appendix B for more information.
- **Case 3:** The calculator displays `BAD GUESSES: PRESS [CLR] TO VIEW`. The Solver cannot begin the search with the current guesses. Press  $\blacktriangleleft$  or  $\boxed{\text{CLR}}$  to view the starting guesses. To supply new guesses, see “Entering Guesses,” below.
- **Case 4:** The calculator displays `SOLUTION NOT FOUND`. Check to see if your equation and stored values are correct. If the equation is correct, you might be able to find a solution by entering very good guesses.

## Halting and Restarting the Iterative Search

When the Solver is iteratively searching for a solution (in other words, when the Solver is displaying sets of estimates), you can halt the calculation by pressing any key except  $\boxed{\text{ENTER}}$ . The calculator displays the message `INTERRUPTED`. To see the best estimate the Solver has found so far, press  $\boxed{\text{CLR}}$  or  $\blacktriangleleft$ . You can restart the search from where it left off by pressing the menu key for the variable you are solving for. Or, you can restart the search using your own guesses (see “Entering Guesses,” below).

## Entering Guesses

Entering your own guesses serves two purposes. First, it can save time by telling the Solver where to start searching. Second, if more than one solution exists, entering guesses may lead the Solver to a solution in a specified range. The closer your guesses are to the desired solution, the better chance the Solver has of finding it.

You can enter guesses at these times:

- Before beginning the calculation, after you've stored a value for every variable except the unknown variable. If you enter one guess, the Solver generates a second guess.
- After you've halted the iterative search.
- After the Solver has returned an answer, and you wish to begin searching for another answer.

You can enter one or two guesses. If you enter one guess, the Solver makes a second guess. If you enter two guesses, the Solver uses those two guesses to start searching for a solution. The Solver works most efficiently when the answer is between your two guesses. For example, if you know the answer is between 5 and 12, you should enter 5 and 12 as the starting guesses.

To enter one guess, key in the value and press the menu key twice. For example, 4.5   enters 4.5 as a guess for a Solver variable named A and starts the calculation.

To enter two guesses, key in the first guess and press the menu key. Then key in the second guess and press the menu key twice. For example, 0  100   causes the Solver to search for A using 0 and 100.

**Example: Using Guesses to Find a Solution Iteratively.** One equation for calculating the profit from a manufacturing operation is:

$$\text{Profit} = (\text{Price} \times \text{Quantity}) - (\text{Variable costs} \times \text{Quantity}) - \text{Fixed Costs}$$

The C-Sharp Piano Corporation sells pianos for \$6,000. Variable costs are \$4,100; fixed costs per year are \$112,000. How many pianos must C-Sharp sell this year in order to earn a profit of \$130,000? (In past years, C-Sharp has had to sell between 100 and 200 pianos to make an acceptable profit. You can use this information as initial guesses.)

Press **SOLVE** **NEW** , then enter the equation:

$$\text{PROFIT} = \text{PRICE} \times \text{QTY} - \text{VARCOST} \times \text{QTY} - \text{FIXCOST}$$

Keys:	Display:	Description:
<b>INPUT</b> <b>CALC</b>		Stores, verifies, and creates labels for the equation.
6000 <b>PRICE</b>	PRICE=6,000.00	Stores price.
4100 <b>VARCO</b>	VARCOST=4,100.00	Stores variable cost,
112000 <b>FIXCO</b>	FIXCOST=112,000.00	fixed cost, and profit.
130000 <b>PROFI</b>	PROFIT=130,000.00	

The following steps enter guesses for *QTY*. If the Solver must search iteratively to solve for *QTY*, it will begin by using the estimates 100 and 200.

Keys:	Display:	Description:
100 <b>QTY</b>	QTY=100.00	The first guess for <i>QTY</i> .
200 <b>QTY</b>	QTY=200.00	The second guess for <i>QTY</i> .

## 182 12: The Equation Solver

QTY

QTY: 200.000000000-Solves for QTY iteratively.

QTY: 100.000000000+

.

.

.

QTY=127.37

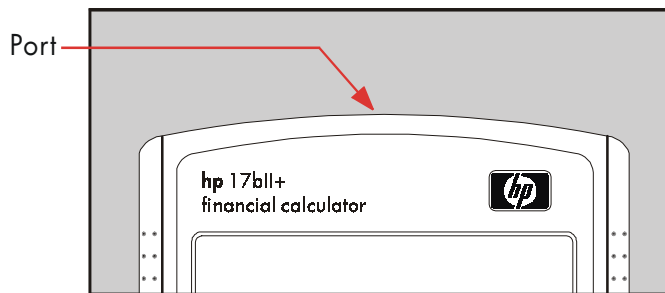
## 12: The Equation Solver 183


# 13

## Printing


---

The calculator can print information using the HP 82240 Infrared Printer, which accepts the infrared signal from the printer port. This chapter describes information you can print. Operation of the printer is covered in the printer owner's manual.\*



The print annunciator (  ) appears in the display whenever the calculator sends information through its printer port.

Because communication goes only one way—from calculator to printer—the calculator cannot determine whether the printer is receiving information. If a printing operation involves many lines of information, the calculator slows its transmission rate to allow the printer time to print.

To preserve battery power, the calculator will not transmit data to the printer when the low-power annunciator (  ) is on. If a low-power condition occurs after you've started a printing operation, printing stops and the calculator displays the message `BATT TOO LOW TO PRINT`.

\* Since the hp-17bII+ cannot send control characters to the printer, portions of the printer's manual pertaining to control codes and graphics characters do not apply.





### 184 13: Printing



---

## The Printer's Power Source




The speed of the printer depends on whether it is using its optional ac adapter. To optimize printing performance, set the printing speed mode in the calculator appropriately. To view or change the printing speed mode:

1. Press  (MODES).
2. Press  to change and display the new mode. If necessary, press  again to set the desired mode:
  - PRINTER : AC ADAPTER
  - PRINTER : NO AC ADAPTER
3. Press .

For long printing operations, printing will be faster using the printer's ac adapter and the calculator's appropriate printing speed mode. When the printer is powered by batteries alone, be sure to change the mode to `PRINTER : NO AC ADAPTER` so that the calculator will not transmit data too rapidly.


---

## Double — Space Printing

Press  (MODES)  to turn double-space printing on or off. Then press .

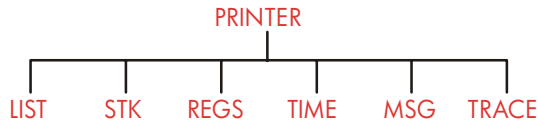
---

## Printing the Display()


To print whatever is in the calculator line, press . This prints numbers, expressions, single Solver equations, and messages. Menus cannot be printed.

---







## Printing Other Information ( PRINTER )




The PRINTER menu provides the ability to print most of the information you've stored, including the contents of variables, lists, appointments, the history stack, registers, and the current date and time. You can also transmit descriptive notes to label the output. (To print amortization schedules, see "Printing an Amortization Table," page 81.)



From within any menu you can press  PRINTER to bring up the PRINTER menu. This table summarizes those printing activities.

**Table 13-1. The PRINTER Menu Labels**

Menu Label	Description
	Prints data stored or calculated in the current menu. See "Printing Variables and Lists," below.
	Prints the contents of the history stack.
	Prints the contents of registers 0 through 9.
	Prints the current date and time.
	Displays the ALPHA menu for typing a message up to 22 characters long. See page 188.
	Switches between Trace On and Trace Off modes. See "Trace Printing," page 188.

Upon completion, all of these functions except  return the previous menu to the display.

### Printing Variables, Lists, and Appointments (LIST)


You can list specific sets of information stored in menus by pressing   while the relevant menu labels are displayed.

**Printing the Values Stored in Variables.** You can print a listing giving the values of all variables whose menu labels are displayed.\*

For example, if the calculator is in the FIN TVM menu, it displays the labels **N** **I%YR** **PV** **PMT** **FV** **OTHER** .

Pressing  **PRINTER** **LIST** now produces a print-out like this:


```
N=          360.00
I%YR=       12.50
PV=        65,000.00
PMT=       -693.00
FV=          8.00
P/YR=       12.00
END MODE
```

**Printing Number Lists.** To print out the contents of a particular SUM or CFLO list, that list must be the *current* list. Pressing  **PRINTER** **LIST** while a SUM list named SALES is the current list produces labeled output like this:


```
NAME: SALES

ITEM#      VALUE
1          1,400.00
2           920.00
3          1,100.00
4          2,265.00
TOTAL=     5,685.00
```


**Printing Solver Equations.** To print one or all Solver equations, display the main SOLVE menu (press **SOLVE** ).

- To print just the current equation, press **PRT** .
- To print out the entire list of equations, press  **PRINTER** **LIST** .

\* Except *IRR%*. Instead, press **IRR%** **PRT** to print the value for *IRR%*.


**Printing Appointments.** To print all stored appointments, display the **APPT** menu (press **APPT** then press  **LIST**). This produces a listing like this for each appointment:

```
1: WED 07/23/03 10:00A
  DEMO FOR SMITH
  RPT=NONE
```

**Menus Not Associated with Stored Data.** Remember that many menu labels do not represent data, but rather activities, such as **FIN**, **BUS**, **DELET** and **SET**. They contain no information for printing. The calculator beeps if there is nothing to print when you press  **LIST**.


## Printing Descriptive Messages (MSG)

You can include descriptive messages with your printed output by using **MSG**. For example, suppose you wanted to print a number that represents the balance for September. You could start the output with the label "SEPTEMBER BALANCE".

1. Press , then **MSG**. This brings up the ALPHA menu.
2. Type (and edit) the label or message.
3. Press **INPUT** to print out the label or message.

Now print out the number itself (if it's in the calculator line, press **PRT**).

## Trace Printing (TRACE)

Trace printing produces a record of all the keys you've pressed and of calculated results. When tracing is *off*, use **PRT** and  to print what you want. When tracing is on, the calculator uses more power and operates more slowly.

To switch trace printing on and off:

1. Press .

## 188 13: Printing

2. Press **TRACE** to change the setting. A message informs you that tracing is on or off. If necessary, press **TRACE** again to display the desired message.
3. Press **EXIT**.

**Example: Trace-Printing an Arithmetic Calculation.** Produce a record of the keystrokes you use to do the following calculation and store the result in the TVM variable *PMT*.

$$\frac{1}{12} \times 4,800 + 125$$

Press **PRINTER** **TRACE** to set **PRINT MODE: TRACE ON**. If you see **PRINT MODE: TRACE OFF**, press **TRACE** again.

<b>Keys:</b>	<b>Print-out:</b>
<b>EXIT</b>	EXIT
<b>FIN</b>	FIN
<b>TVM</b>	TVM
12 <b>1/x</b>	12.00 1/x
	0.08 ***
✓ <b>⊗</b>	×
✓ 4800 <b>+</b>	4,800.00 +
✓ 125 <b>=</b>	125.00 =
	525.00 ***
<b>PMT</b>	PMT
<b>PRINTER</b>	PRINTER
<b>TRACE</b>	TRACE
<b>EXIT</b>	

### How to Interrupt the Printer

Pressing a calculator key during a printing operation will interrupt transmission, but not immediately stop the printing.

To stop the printer immediately, turn it off.

# 14

## Additional Examples

---

### Loans

#### Simple Annual Interest

See appendix F for RPN keystrokes for this example.

**Example: Simple Interest at an Annual Rate.** Your good friend needs a loan to start her latest enterprise and has requested that you lend her \$450 for 60 days. You lend her the money at 7% simple annual interest, to be calculated on a 365-day basis. How much interest will she owe you in 60 days, and what is the total amount owed?

$$\text{The interest is: } (7\% \text{ of } \$450) \times \frac{60 \text{ days}}{365 \text{ days}}$$

✓ Keys:	Display:	Description:
450 $\times$ 7 $\%$	450.00 $\times$ 0.07	Annual interest.
$\times$ 60 $\div$ 365		Actual interest for 60
$+$	5.18+	days.
450 $=$	455.18	Add principal to get total debt

#### A Solver Equation for Simple Annual Interest:

$$DEBT = LOAN + LOAN \times I\% \div 100 \times DAYS \div 365$$

*DEBT* = the total owed at the end of the loan period.

*LOAN* = the original amount (principal) lent.

*I%* = the annual interest rate as a percent.

*DAYS* = the number of days in the loan.

### 190 14: Additional Examples

For instructions on entering Solver equations, see "Solving Your Own Equations," on page 29.

If you know the dates for the course of the loan, rather than the number of days, use this for an actual-calendar basis:

$$\text{DEBT} = \text{LOAN} + \text{LOAN} \times \text{I\%} \div 100 \times \text{DDAYS}(\text{DATE1} : \text{DATE2} : 1) \div 365$$

or use this for a 360-day basis:

$$\text{DEBT} = \text{LOAN} + \text{LOAN} \times \text{I\%} \div 100 \times \text{DDAYS}(\text{DATE1} : \text{DATE2} : 3) \div 360$$

*DATE1* = the date the loan commences.

*DATE2* = the date the loan ends.

## Yield of a Discounted (or Premium) Mortgage

The annual yield of a mortgage bought at a discount or premium can be calculated given the original mortgage amount (*PV*), interest rate (*I%YR*), periodic payment (*PMT*), balloon payment amount (if any) (*FV*), and the price paid for the mortgage (new *PV*).

Remember the cash-flow sign convention: money paid out is negative, money received is positive.

**Example: Discounted Mortgage.** An investor wishes to purchase a \$100,000 mortgage taken out at 9% for 20 years. Since the mortgage was issued, 42 monthly payments have been made. The loan is to be paid in full (a *balloon payment*) at the end of its fifth year. What is the yield if the purchase price of the mortgage is \$79,000?

1. Since the payment amount (*PMT*) is not given, calculate it first. To do this, first assume 20 years' amortization on the original mortgage with no balloon payment (so  $N = 20 \times 12$ ,  $FV = 0$ ,  $PV = -100,000$ , and  $I\%YR = 9$ ).
2. Since the balloon amount is not given, calculate it (*FV*) next. Use *PMT* from step 1, but change *N* to 5 years ( $N = 5 \times 12$ ).

3. Finally enter current values for  $N$  (less number of payment periods already passed, or  $5 \times 12 - 42$ ) and  $PV$  (proposed purchase price, \$79,000); then calculate  $I\%YR$  for the annual yield.

**Step 1:** Calculate  $PMT$ . Make sure  $FV = 0$ .

<b>Keys:</b>	<b>Display:</b>	<b>Description:</b>
FIN TVM		Selects menu; sets 12 payments per year and End mode.
OTHER		
<input type="checkbox"/> CLR DATA		
EXIT	12 P/YR END MODE	
20 <input type="checkbox"/> N	N=240.00	Figures and stores <i>total</i> number of payments for a full 20-year loan with monthly payments.
9 I%YR		Stores interest rate and amount of original loan.
100000 <input type="checkbox"/>		(Money paid out is negative.)
PV	PV=-100,000.00	
0 FV	FV=0.00	Sets $FV$ to zero.
PMT	PMT=899.73	Calculates monthly payment received.

**Step 2:** Enter the new value for  $N$  given a balloon in 5 years, then find  $FV$ , the amount of the balloon.

<b>Keys:</b>	<b>Display:</b>	<b>Description:</b>
5 <input type="checkbox"/> N	N=60.00	Stores number of payments for 5 years.
FV	FV=88,707.05	Calculates balloon due in 5 years.

## 192 14: Additional Examples



**Step 3:** Enter actual, current values for  $N$  and  $PV$ ; then find new  $I\%YR$  for discounted mortgage with balloon.

Keys:	Display:	Description:
<input type="text" value="RCL"/> <input type="text" value="N"/>		
✓ <input type="text" value="42"/> <input type="text" value="N"/>	$N=18.00$	Stores number of payments remaining in 5-year loan.
<input type="text" value="79000"/> <input type="text" value="+/-"/>		
<input type="text" value="PV"/>	$PV=-79,000$	Stores proposed, discounted purchase price (new present value).
<input type="text" value="I%YR"/>	$I\%YR=20.72$	Calculates percent annual yield.

## Annual Percentage Rate for a Loan with Fees

See appendix F for RPN keystrokes for the next two examples.

The *annual percentage rate*, APR, incorporates fees usually charged when a mortgage is issued, which effectively raises the interest rate. The actual amount received (the  $PV$ ) by the borrower is reduced, while the periodic payments remain the same. The APR can be calculated given the term of the mortgage ( $N$  periods), the annual interest rate ( $I\%YR$ ), the mortgage amount (new  $PV$ ), and the basis of the fee charged (how the fee is calculated).

Remember the cash-flow sign convention: money paid out is negative, money received is positive.

**Example: APR for a Loan with Fees.** A borrower is charged two points for the issuance of a mortgage. (One point is equal to 1% of the mortgage amount.) If the mortgage amount is \$60,000 for 30 years and the interest rate is  $11\frac{1}{2}\%$  annually with monthly payments, what APR is the borrower paying?

1. Since the payment amount is not given, calculate it (*PMT*) first. Use the given mortgage amount ( $PV = \$60,000$ ) and interest rate ( $I\%YR = 11\frac{1}{2}\%$ ).
2. To find the APR (the new  $I\%YR$ ), use the *PMT* calculated in step 1 and adjust the mortgage amount to reflect the points paid ( $PV = \$60,000 - 2\%$ ). All other values remain the same (term is 30 years; no future value).

Keys:	Display:	Description:
FIN		If necessary, sets 12 payments per year and End mode.
TVM		
OTHER		
<input type="checkbox"/> CLR DATA		
EXIT	12 P/YR END MODE	
30 <input type="checkbox"/> N	N=360.00	Figures and stores number of payments.
11.5 I%YR		Stores interest rate and amount of loan.
60000 PV	PV=60,000.00	
0 FV	FV=0.00	No balloon payment, so future value is zero.
PMT	PMT=-594.17	Borrower's monthly payment.
RCL PV		Stores actual amount of money received by borrower into <i>PV</i> .
<input checked="" type="checkbox"/> 2 %		
PV	PV=58,800.00	
I%YR	I%YR=11.76	Calculates APR.

**Example: Loan from the Lender's Point of View.** A \$1,000,000, 10-year, 12% (annual interest) interest-only loan has an origination fee of 3 points. What is the yield to the lender? Assume that monthly payments of interest are made. (Before figuring the yield, you must

## 194 14: Additional Examples

calculate the monthly  $PMT = (loan \times 12\%) \div 12 \text{ mos.}$  When calculating the  $I\%YR$ , the  $FV$  (a balloon payment) is the entire loan amount, or \$1,000,000, while the  $PV$  is the loan amount minus the points.

<b>Keys:</b>	<b>Display:</b>	<b>Description:</b>
FIN TVM		If necessary, sets 12
OTHER		payments per year and
CLR DATA  EXIT	12 P/YR END MODE	End mode.
10  N	N=120.00	Stores total number of
		payments.
✓ 1000000  X		Calculates annual interest
✓ 12  %  ÷	120,000.00 ÷	on \$1,000,000 ...
12  PMT	PMT=10,000.00	...and calculates, then
		stores monthly payment.
1000000		Stores entire loan amount
FV	FV=1,000,000.00	as balloon payment.
✓  - 3  %  =		Calculates, then stores
+/-  PV	PV=-970,000.00	amount borrowed (total —
		points).
I%YR	I%YR=12.53	Calculates APR—the yield
		to lender.

### Loan with an Odd (Partial) First Period

The TVM menu deals with financial transactions in which each payment period is the same length. However, situations exist in which the first payment period is not the same length as the remaining periods. This first period is sometimes called an *odd* or *partial first period*.

The following Solver equation calculates  $N$ ,  $I\%$ ,  $PV$ ,  $PMT$ , or  $FV$  for transactions involving an odd first period, using simple interest for the odd period. The formula is valid for 0 to 59 days from inception to

first payment, and a 30-day month is assumed.\*

### A Solver Equation for Odd-Period Calculations:

$$\text{ODD: } PV \times (I\% \div 100 \times FP(DAYS \div 30) + 1) = -IF(DAYS < 30: (1 + I\% \div 100) \times PMT : PMT) \times USPV(I\% : N) - FV \times SPPV(I\% : N)$$

(For the < character, press **WXYZ** **OTHER** **<** **.**)

*PV* = the loan amount.

*I%* = the periodic interest rate.

*DAYS* = the actual number of days until the first payment is made.

*PMT* = the periodic payment.

*N* = the total number of payment periods.

*FV* = the balloon payment. A balloon payment occurs at the end of the last (*N*th) period and is in addition to any periodic payment.

The following examples assume that you have entered the equation named ODD, above, into the Solver. For instructions on entering Solver equations, see "Solving Your Own Equations," on page 29.

**Example: Loan with an Odd First Period.** A 36-month loan for \$4,500 has an annual interest rate of 15%. If the first payment is made in 46 days, what is the monthly payment amount?

Select equation ODD in the Solver.

Keys:	Display:	Description:
<b>CALC</b>		Creates menu.
36 <b>N</b>	N=36.00	36 payment periods.
4500 <b>PV</b>	PV=4,500.00	Stores loan amount.
✓ 15 <b>÷</b> 12		Stores <i>periodic</i> , monthly

\* You do not need to specify Begin or End mode. If the number of days until the first payment is less than 30, Begin mode is assumed. If the number of days until the first payment is between 30 and 59, inclusive, End mode is assumed.

## 196 14: Additional Examples

I%	I%=1.25	interest rate.
46 DAYS	DAYS=46.00	Stores days until first payment.
0 FV	FV=0.00	No balloon payment.
PMT	PMT=-157.03	Calculates payment.

**Example: Loan with an Odd First Period Plus Balloon.** A \$10,000 loan has 24 monthly payments of \$400, plus a balloon payment of \$3,000 at the end of the 24th month. If the payments begin in 8 days, what annual interest rate is being charged?

Select equation ODD.

Keys:	Display:	Description:
CALC		Creates menu.
10000 FV	PV=10,000.00	Stores known values.
24 N	N=24.00	
400 +/- PMT	PMT=-400.00	
3000 +/-		
FV 8 DAYS	FV=-3,000.00 DAYS=8.00	
I%	I%=1.64	Calculates <i>periodic</i> (monthly) interest rate.
✓ ⊗ 12 ☰	19.67	Annual interest rate.

## Canadian Mortgages

In Canadian mortgages, the compounding and payment periods are not the same. Interest is compounded semi-annually while payments are made monthly. To use the TVM menu in the HP 17bII+, you need to calculate a *Canadian mortgage factor* to store as *I%YR*.

1. Set End mode and store 12 **P/YR**.

## 14: Additional Examples 197

2. Store 0 **PMT**, 6 **N**, and 200 **PV**.
3. Add 200 to the annual interest rate, make the number negative, and store it in **FV**.
4. Press **I%YR** to calculate the Canadian mortgage factor.
5. Continue the problem by supplying the other mortgage values and solving for the unknown item. *Do not change I%YR from step 4.*

**Example: Canadian Mortgage.** What is the monthly payment required to fully amortize a 30-year, \$30,000 Canadian mortgage if the interest rate is 12%?

<b>Keys:</b>	<b>Display:</b>	<b>Description:</b>
<b>FIN</b> <b>TVM</b>		Displays TVM menu; sets
<b>OTHER</b> <b>CLR DATA</b>		12 payments per year
<b>EXIT</b>	12 P/YR END MODE	with End mode.
0 <b>PMT</b>	PMT=0.00	
6 <b>N</b>	N=6.00	
200 <b>PV</b>	PV=200.00	
✓ <b>+ 12</b> <b>=</b> <b>+/-</b>		
<b>FV</b>	FV=-212.00	
<b>I%YR</b>	I%YR=11.71	Calculates I%YR for Canadian mortgage factor.
30 <b>CLR</b> <b>N</b>	N=360.00	Stores other values.
30000 <b>PV</b>	PV=30,000.00	
0 <b>FV</b>	FV=0.00	
<b>PMT</b>	PMT=-301.92	Monthly payment.

### A Solver Equation for Canadian Mortgages:

$$\text{CAN: } PV = -PMT \times USPV((1 + I\%YR + 200)^{(1 \div 6)} - 1) \times 100 : N) - FV \times SPPV((1 + I\%YR + 200)^{(1 \div 6)} - 1) \times 100 : N)$$

## 198 14: Additional Examples

(For the  $\wedge$  operator press  $\square$   $y^x$ .)

$PV$  = loan amount, or present value.

$PMT$  = monthly payment amount.

$I\%YR$  = annual (Canadian) interest rate as a percent.

$N$  = total number of payment periods for the life of the loan.

$FV$  = remaining balance, or future value.

For instructions on entering Solver equations, see "Solving Your Own Equations," on page 29.

## Advance Payments (Leasing)

Occasionally payments are made in advance, such as in leasing. Leasing agreements sometimes call for the extra payments to be made when the transaction is closed. A residual value (*salvage value*) can also exist at the end of the normal term.

The following equation calculates the monthly payment and the annual yield when one or more payments are made in advance. It can be modified to accommodate periods other than monthly by changing the number 12 to the appropriate number of payment periods per year.

Remember the cash-flow sign convention: money paid out is negative, money received is positive.

### A Solver Equation for Advance Payments:

$$ADV: PMT = (-PV - FV \times (SPPV(I\%YR \div 12 : N))) \div (USPV(I\%YR \div 12 : N - \#ADV) + \#ADV)$$

(For the # character press  $\square$   $WXYZ$   $\square$   $OTHER$   $\square$   $\#$   $\square$ .)

$PMT$  = the monthly payment amount.

$PV$  = the value of the equipment.

$FV$  = the residual value.

## 14: Additional Examples 199

$I\%YR$  = the annual interest rate as a percent.

$N$  = the total number of payments.

$\#ADV$  = the number of advance payments.

The following example assumes that you have entered the equation ADV, above, into the Solver. For instructions on entering Solver equations, see "Solving Your Own Equations," on page 29.

**Example: Leasing with Advance Payments.** Equipment worth \$750 is leased to you for 12 months. The equipment is assumed to have no salvage value at the end of the lease. You agree to make three payments at the time of closing. What is the monthly payment if the annual interest rate is 10%?

Select the ADV equation in the Solver.

Keys:	Display:	Description:
CALC		Creates menu.
750 PV		Stores known values.
12 N		
0 FV		
3 #ADV		
10 I%YR	I%YR=10.00	
PMT	PMT=-64.45	Calculates payment.

---

## Savings

### Value of a Fund with Regular Withdrawals

**Example: A Fund with Regular Withdrawals.** What are the balances after 1, 10, and 20 years of a fund that starts at \$750,000, has \$20,000 withdrawn at the beginning of each quarter, and earns 10% annual interest compounded monthly?

### 200 14: Additional Examples



1. Because the compounding periods and the withdrawal periods are not coincident, you must first convert the nominal interest rate to one in terms of the withdrawal periods. You can do this using the ICNV menu, as explained on page 87, "Compounding Periods Different from Payment Periods."
2. The rest of the calculation is a straightforward TVM problem. Remember that money deposited is paid out and therefore negative; money withdrawn is received and therefore positive.

**Step 1:** Find the adjusted nominal interest rate.

Keys:	Display:	Description:
FIN ICNV PER	COMPOUNDING P TIMES/YR	Displays periodic interest-rate conversion menu.
12 P	P=12.00	Stores number of compounding periods.
10 NOM%	NOM%=10.00	Stores nominal interest rate.
EFF%	EFF%=10.47	Calculates effective interest rate.
4 P	P=4.00	Stores number of withdrawal periods.
NOM%	NOM%=10.08	Calculates adjusted nominal interest rate.

**Step 2:** Calculate the future values.

Keys:	Display:	Description:
EXIT EXIT TVM		Switches to TVM menu.

## 14: Additional Examples 201

◀		10.00	Clears message to show NOM% value still in calculator line.
STO	I%YR	I%YR=10.00	Stores adjusted nominal interest rate in I%YR.
OTHER			Sets 4 payments (withdrawals) per year and Begin mode.
4	P/YR		
BEG	EXIT	4 P/YR BEGIN MODE	
750000	+/-		Stores present (initial) value of fund.
PV		PV=-750,000.00	
20000	PMT	PMT=20,000.00	Stores withdrawal amount.
4	N	N=4.00	Stores number of withdrawals in 1 year.
FV		FV=743,364.31	Value of fund at end of year 1.
40	N	N=40.00	Stores number of withdrawals over 10 years.
FV		FV=641,824.41	Calculates value of fund at end of year 10.
20	☐ N	N=80.00	Stores number of withdrawals after 20 years.
FV		FV=348,988.60	Calculates value of fund at end of year 20.

## Deposits Needed for a Child's College Account

See appendix F for RPN keystrokes for this example.

### 202 14: Additional Examples

Suppose you want to start saving now to accommodate a future series of cash outflows. An example of this is saving money for college. To determine how much you need to save each period, you must know when you'll need the money, how much you'll need, and at what interest rate you can invest your deposits.

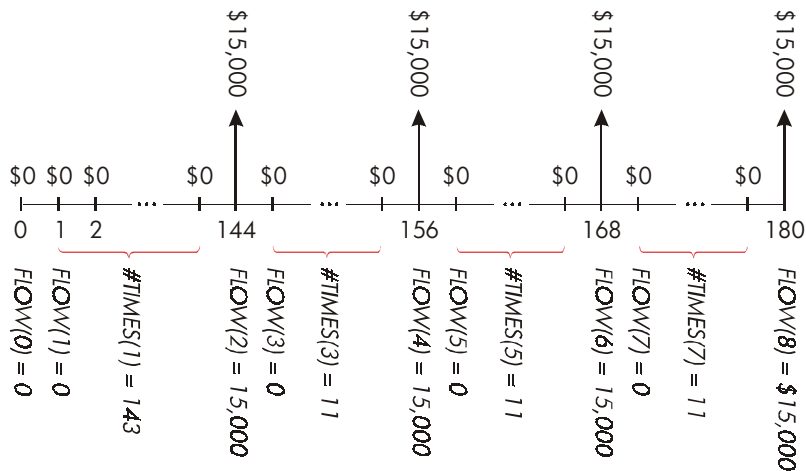
Use a CFLO list to calculate the net uniform series (*NUS*) of the future withdrawals:

1. Store zero for all cash flows except the withdrawals. For those cash flows, store the amounts you will need to withdraw (since this is cash received, these cash flows will be *positive*).
2. Store the periodic interest rate in *I%* and calculate *NUS*. The *NUS* equals the amount of the monthly deposit you will need to make.

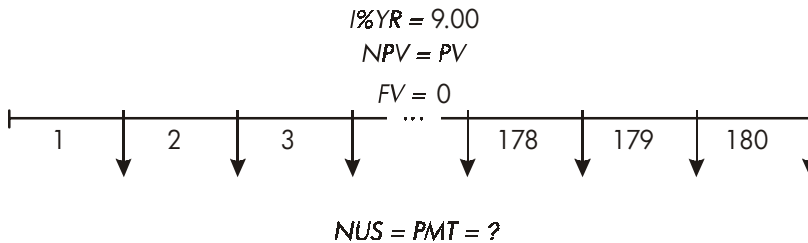
You can also calculate the equivalent present value of all the monthly deposits combined by calculating the net present value, *NPV*.

**Example: Savings for College.** Your daughter will be going to college in 12 years and you are starting a fund for her education. She will need \$15,000 at the beginning of each year for four years. The fund earns 9% annually, compounded monthly, and you plan to make monthly deposits, starting at the end of the current month. How much should you deposit each month to meet her educational expenses?

The cash-flow diagram looks like this:



**Figure 14-1. Flow of Withdrawals**



**Figure 14-2. Flow of Deposits**

**Keys:**

FIN  
CFLO

CLR DATA YES

or

GET \*NEW FLOW(0)=?

**Display:**

**Description:**

Displays current cash-flow list and CFLO menu keys.

Clears current list or gets a new one.

**204 14: Additional Examples**

**Step 1:** Set up a CFLO list.

0	<input type="text"/>	FLOW(1)=?	Sets initial cash flow, <i>FLOW(0)</i> , to zero.
0	<input type="text"/>	#TIMES(1)=1	Stores zero in <i>FLOW(1)</i> and prompts for the number of times it occurs.
✓ 12	<input type="text"/> <input type="text"/> 12 <input type="text"/> 1		
	<input type="text"/>	FLOW(2)=?	Stores 143 (for 11 years, 11 months) in <i>#TIMES(1)</i> for <i>FLOW(1)</i> .
15000	<input type="text"/>	#TIMES(2)=1	Stores amount of first withdrawal, at end of 12th year.
	<input type="text"/>	FLOW(3)=?	
0	<input type="text"/>	#TIMES(3)=1	Stores cash flows of zero...
11	<input type="text"/>	FLOW(4)=?	...for the next 11 months.
15000	<input type="text"/>		Stores second withdrawal, for sophomore year.
	<input type="text"/>	FLOW(5)=?	
0	<input type="text"/>		Stores cash flows of zero for the next 11 months.
11	<input type="text"/>	FLOW(6)=?	
15000	<input type="text"/>		Stores third withdrawal, for junior year.
	<input type="text"/>	FLOW(7)=?	
0	<input type="text"/>		Stores cash flows of zero for the next 11 months.
11	<input type="text"/>	FLOW(8)=?	
15000	<input type="text"/>		Stores fourth withdrawal, for senior year.
	<input type="text"/>	FLOW(9)=?	
	<input type="text"/> <input type="text"/>	NPV, NUS, NFV	Done entering cash flows; gets CALC menu.
		NEED I%	

**14: Additional Examples 205**

**Step 2:** Calculate *NUS* for the monthly deposit.

<b>Keys:</b>	<b>Display:</b>	<b>Description:</b>
✓ 9 $\square$ 12 I%	I%=0.75	Figures the periodic (monthly) interest rate and stores it in I%.
NUS	NUS=182.30	Amount of monthly deposit needed to meet planned withdrawals.
NPV	NPV=17,973.48	Calculates the net present value of the monthly deposits, which is the same as the <i>NPV</i> of the four future withdrawals.

## Value of a Tax-Free Account

See appendix F for RPN keystrokes for this example.

You can use the TVM menu to calculate the future value of a tax-free or tax-deferred account, such as an IRA or Keogh account. Remember that for calculations with cash flows, money paid out is negative and money received is positive. (Current tax law and your current income will determine whether just interest or also principal are tax-free, and for how long. You can solve for either case.)

*N* = the number of payments until retirement.

*I%YR* = the annual dividend rate.

*PV* = the present value of the retirement account.

*PMT* = the amount of your deposit. (It must be constant for the duration of the account.)

*FV* = the future value of the retirement account.

The purchasing power of that future value depends on the inflation rate and the duration of the account.

## 206 14: Additional Examples

**Example: Tax-Free Account.** Consider opening an IRA account with a dividend rate of 8.175%. 1) If you invest \$2,000 at the beginning of each year for 35 years, how much will you have at retirement? 2) How much will you have paid into the IRA? 3) How much interest will you have earned? 4) If your post-retirement tax rate is 15%, what is the after-tax future value of the account? Assume only the interest will be taxed. (Assume the principal was taxed before deposit.) 5) What is the purchasing power of that amount, in today's dollars, assuming an 8% annual inflation rate?

**Keys:**

**Display:**

**Description:**

FIN	TVM		Sets 1 payment per year and Begin mode.
OTHER			
1	P/YR	1 P/YR BEGIN MODE	
BEG	EXIT		
35	N	N=35.00	Stores number of payment periods until retirement (1 × 35).
8.175	I/YR	I/YR=8.18	Stores dividend rate.
0	PV	PV=0.00	Present value of account (before first payment).
2000	+/-		Annual payment (deposit).
PMT		PMT=-2,000.00	
FV		FV=387,640.45	Calculates amount in account at retirement.
RCL	PMT		Calculates total amount paid into IRA by retirement.
✓	×	RCL	
✓	N	=	-70,000.00
✓	+	RCL	
✓	FV	=	317,640.45

**14: Additional Examples 207**

✓	⊗ 15 % =	47,646.07	Taxes at 15% of interest.
✓	+/- + RCL		Subtracts taxes from total
✓	FV =	339,994.39	FV to calculate after-tax FV.
	FV	FV=339,994.39	Stores after-tax future value in FV.
	8 I%YR		Calculates present-value
	0 PMT		purchasing power of the
	PV	PV=-22,995.36	above after-tax FV at 8% inflation rate.

## Value of a Taxable Retirement Account

See appendix F for RPN keystrokes for this example.

This problem uses the TVM menu to calculate the future value of a *taxable* retirement account that receives regular, annual payments beginning today (Begin mode). The annual tax on the interest is paid out of the account. (Assume the deposits have been taxed already.)

$N$  = the number of years until retirement.

$I\%YR$  = the annual interest rate diminished by the tax rate:  
 $interest\ rate \times (1 - tax\ rate)$ .

$PV$  = the current amount in the retirement account.

$PMT$  = the amount of the annual payment.

$FV$  = the future value of the retirement account.

**Example: Taxable Retirement Account.** If you invest \$3,000 each year for 35 years, with dividends taxed as ordinary income, how much will you have in the account at retirement? Assume an annual dividend rate of 8.175% and a tax rate of 28%, and that payments begin today. What will be the purchasing power of that amount in today's dollars, assuming 8% annual inflation?

## 208 14: Additional Examples



**Keys:**

FIN TVM  
 OTHER 1 P/YR  
 BEG EXIT  
 35 N

**Display:**

1 P/YR BEGIN MODE  
 N=35.00

**Description:**

Displays TVM menu.  
 Sets 1 payment per year and Begin mode.  
 Stores years until retirement.  
 Calculates and stores interest rate diminished by tax rate.  
 Stores no present value.  
 Stores annual payment.  
 Calculates future value.  
 Calculates present-value purchasing power of the above *FV* at 8% inflation.

✓ 8.175  $\square$  28  $\square$  8.18-2.29  
 ✓ I%YR I%YR=5.89

0 PV PV=0.00  
 3000  $\square$  PMT PMT=-3,000.00  
 FV FV=345,505.61  
 8 I%YR  
 0 PMT  
 PV PV=-23,368.11

---

## Modified Internal Rate of Return

When there is more than one sign change (positive to negative or negative to positive) in a series of cash flows, there is a potential for more than one *IRR*%. For example, the cash-flow sequence in the following example has three sign changes and hence up to three potential internal rates of return. (This particular example has three positive real answers: 1.86, 14.35, and 29.02% monthly.)

The Modified Internal Rate of Return (MIRR) procedure is an alternative that can be used when your cash-flow situation has multiple sign changes. The procedure eliminates the sign change problem by utilizing reinvestment and borrowing rates that you specify. Negative cash flows are discounted at a *safe rate* that reflects the return on an investment in

## 14: Additional Examples 209

a liquid account. The figure generally used is a short-term security (T-bill) or bank passbook rate. Positive cash flows are reinvested at a *reinvestment rate* that reflects the return on an investment of comparable risk. An average return rate on recent market investments might be used.

1. In the CFLO menu, calculate the present value of the *negative* cash flows (*NPV*) at the *safe* rate and store the result in register 0. Enter zero for any cash flow that is positive.
2. Calculate the future value of the *positive* cash flows (*NFV*) at the *reinvestment* rate and store the result in register 1. Enter zero for any cash flow that is negative.
3. In the TVM menu, store the total number of periods in *N*, the *NPV* result in *PV*, and the *NFV* result in *FV*.
4. Press **I%YR** to calculate the periodic interest rate. This is the modified internal rate of return, MIRR.

**Example: Modified IRR.** An investor has an investment opportunity with the following cash flows:

Group (FLOW no.)	No. of Months (#TIMES)	Cash Flow, \$
0	1	-180,000
1	5	100,000
2	5	-100,000
3	9	0
4	1	200,000

Calculate the MIRR using a safe rate of 8% and a reinvestment (risk) rate of 13%.

**Keys:**

**FIN** **CFLO**

**CLR DATA** **YES**

**Display:**

**Description:**

Displays current cash-flow list.

Clears current list or gets a

**210 14: Additional Examples**

or

GET #NEW FLOW(0)=?  
180000 +/-  
INPUT FLOW(1)=?  
0 INPUT #TIMES(1)=1

5 INPUT FLOW(2)=?  
100000 +/-  
INPUT #TIMES(2)=1  
5 INPUT FLOW(3)=?

EXIT CALC NPV, NUS, NFV  
NEED I%

✓ 8 ÷ 12  
I% I%=0.67  
NPV NPV=-654,136.81

STO 0 NPV=-654,136.81  
EXIT FLOW(3)=?  
CLR DATA YES FLOW(0)=?  
0 INPUT FLOW(1)=?

100000 INPUT  
5 INPUT FLOW(2)=?  
0 INPUT

new one.

Stores initial cash flow,  
*FLOW(0)*.

Stores *FLOW(1)* as zero  
since the flow amount is  
positive.

Stores 5 for *#TIMES(1)*.

Stores *FLOW(2)*.

Stores *FLOW(2)* 5 times.  
You can skip *FLOW(3)*  
and *FLOW(4)* because  
they are equal to zero for  
this part.

Stores monthly safe  
interest rate.

Calculates *NPV* of  
negative cash flows.

Stores *NPV* in register 0.

Returns to CFLO menu.

Clears list.

Stores zero as *FLOW(0)*.  
(Skip negative flows; store  
positive flows.)

Stores *FLOW(1)* 5 times.

Stores zero for *FLOW(2)*,

## 14: Additional Examples 211

5	<input type="button" value="INPUT"/>	FLOW(3)=?	5 times.
0	<input type="button" value="INPUT"/>		Stores zero for <i>FLOW(3)</i> ,
9	<input type="button" value="INPUT"/>	FLOW(4)=?	9 times.
200000	<input type="button" value="INPUT"/>		Stores <i>FLOW(4)</i> , 1 time.
	<input type="button" value="INPUT"/>	FLOW(5)=?	
	<input type="button" value="EXIT"/> <input type="button" value="CALC"/>	NPV, NUS, NFV	
		NEED I%	
✓13	<input type="button" value="÷"/>	12	
	<input type="button" value="I%"/>	I%=1.08	Stores monthly
	<input type="button" value="NFV"/>	NFV=800,582.75	reinvestment rate.
			Calculates <i>NFV</i> of positive
			cash flows.
	<input type="button" value="STO"/> 1	NFV=800,582.75	Stores <i>NFV</i> in register 1.
	<input type="button" value="MAIN"/> <input type="button" value="FIN"/>		Switches to TVM menu;
	<input type="button" value="TVM"/> <input type="button" value="OTHER"/>		sets 12 periods per year
	<input type="button" value="CLR DATA"/> <input type="button" value="EXIT"/>	12 P/YR END MODE	with End mode, if
			necessary.
20	<input type="button" value="N"/>	N=20.00	Stores total number of
			investment periods.
	<input type="button" value="RCL"/> 0 <input type="button" value="PV"/>	PV=-654,136.81	Recalls present value of
			negative cash flows and
			stores in <i>PV</i> .
	<input type="button" value="RCL"/> 1 <input type="button" value="FV"/>	FV=800,582.75	Recalls future value of
			positive cash flows and
			stores in <i>FV</i> .
0	<input type="button" value="PMT"/>	PMT=0.00	Stores zero in <i>PMT</i> (no
			payments).
	<input type="button" value="I%YR"/>	I%YR=12.18	Calculates annual MIRR.

## 212 14: Additional Examples

---

## Price of an Insurance Policy

The price of an insurance policy, other than term life insurance, is rarely apparent at first glance. The price should include not only the premium payments, but also the interest that could have been earned on the cash value or *savings portion* of the policy.

The following equation calculates the price per \$1,000 of protection for one policy year and the interest rate earned on the savings portion of the policy.

To calculate the price, assume some value for interest—for example, the interest rate you could earn on a one-year savings certificate after tax. Similarly, to calculate interest, assume a price per \$1,000 per year for alternative insurance; for example, a low-cost term policy of the one-year renewable type.

Even complex policies like minimum-deposit plans can be analyzed with this procedure. Use policy surrender values for cash values and the actual (after-tax) amounts for payments (premiums) and dividends.

### A Solver Equation for Insurance Price:

$$INS = \frac{(\text{PREM} + LVAL) \times (1 + I\% \div 100) - VAL - DIV}{.001 \times (\text{FACE} - VAL)}$$

*INS* = the price per \$1,000 of protection in one policy year.

*PREM* = the annual premium amount.

*LVAL* = the value of the policy at the end of last year.

*I%* = the rate of return, as a percent, on a savings account.

*VAL* = the value of the policy at the end of the current year.

*DIV* = the dollar value of the dividend for one year.

*FACE* = the face value of the policy for one year.

The following example assumes that you have entered the above equation into the Solver. For instructions on entering Solver equations, see "Solving Your Own Equations," on page 30.

**Example: Insurance Policy.** You are evaluating your \$50,000 insurance policy. The premium of \$1,010 is due at the beginning of the year, and a dividend of \$165 is received at the end of the policy year. The cash value of the policy is \$3,302 at the beginning of the year; it will grow to \$4,104 by the end of the year. You can earn 6% on a savings account. What is the annual price per \$1,000 protection?

Select the correct equation in the Solver.

Keys:	Display:	Description:
<b>CALC</b>		Creates menu.
1010 <b>PREM</b>	PREM=1,010.00	Stores annual premium.
3302 <b>LVAL</b>	LVAL=3,302.00	Stores value of policy at end of last year.
6 <b>I%</b>	I%=6.00	Stores interest rate you could get elsewhere.
4104 <b>VAL</b>	VAL=4,104.00	Stores value of policy at end of this year.
<b>MORE</b>		Stores annual dividend.
165 <b>DIV</b>	DIV=165.00	
50000 <b>FACE</b>	FACE=50,000.00	Stores face value of policy.
<b>MORE</b> <b>INS</b>	INS=6.57	Your protection cost \$6.57 per \$1,000 face (protection) value.

Insurance protection could be purchased for \$3 per \$1,000 face value. Calculate the rate of return on your savings.

Keys:	Display:	Description:
3 <b>INS</b>	INS=3.00	Stores price of alternate insurance.
<b>I%</b>	I%=2.20	Calculates rate of return.

## 214 14: Additional Examples

Reference: Joseph M. Belth, *Life Insurance—A Consumer's Handbook*, Indiana University Press, 1973, p. 234.

## Bonds

**Example: Yield to Maturity and Yield to Call.** On March 16, 2003 you consider the purchase of a \$1,000 bond that was issued on January 1, 2001. It has a 10.5% semiannual coupon using a 30/360 calendar, and matures on January 1, 2031. The bond is callable on January 1, 2006 at 110 (that is, \$1,100). The bond is now selling at 115.174 (that is, \$1,151.74). Determine both the yield to maturity and the yield to call for this bond.

First, calculate the yield to maturity:

Keys:	Display:	Description:
FIN BOND		Displays BOND menu.
TYPE 360		Sets semiannual bond on 30/360 calendar.
SEMI (EXIT)	30/360 SEMIANNUAL	
<input type="checkbox"/> (CLR DATA)	30/360 SEMIANNUAL	Clears variables; sets CALL to 100.
3.162003 SETT	SETT= 03/16/2003 SUN	Stores today as purchase date.
1.012031 MAT	MAT=01/01/2031 WED	Stores maturity date.
10.5 CPN%	CPN%=10.50	Stores coupon rate.
MORE		Stores price. Displays only two decimal places, but stores all three.
115.174 PRICE	PRICE=115.17	
YLD%	YLD%=9.00	Calculates yield to maturity.

## 14: Additional Examples 215

Second, calculate the yield to call:

Keys:	Display:	Description:
<code>MORE</code>	<code>YLD%=9.00</code>	Returns to first BOND menu.
<code>1.012006</code>		Changes maturity date to the call date.
<code>MAT</code>	<code>MAT=01/01/2006 SUN</code>	
<code>110 CALL</code>	<code>CALL=110.00</code>	Stores call value.
<code>MORE YLD%</code>	<code>YLD%=7.63</code>	Calculates a yield to call.

---

## Discounted Notes

A note is a written agreement to pay to the buyer of the note a sum of money plus interest. Notes do not have periodic coupons, since all interest is paid at maturity. A discounted note is a note that is purchased below its face value. The following equations find the price or yield of a discounted note. The calendar basis is actual/360.

**Solver Equations for Discounted Notes:** To find the price given the discount rate:

$$\text{NOTE: PRICE} = \text{RV} - (\text{DISC} \times \text{RV} \times \text{DDAYS}(\text{SETT}; \text{MAT}; 1) \div 360000)$$

To find the yield given the price (or to find the price given the yield):

$$\text{NOTE: YIELD} = (\text{RV} - \text{PRICE}) \div \text{PRICE} \times 360000 \div \text{DDAYS}(\text{SETT}; \text{MAT}; 1)$$

*PRICE* = the purchase price per \$100 face value.

*YIELD* = the yield as an annual percentage.

*RV* = the redemption value per \$100.

*DISC* = the discount rate as a percent.

*SETT* = the settlement date (in current date format).

*MAT* = the maturity date (in current date format).

## 216 14: Additional Examples



The following example assumes that you have entered the NOTE equations into the Solver. For instructions on entering Solver equations, see "Solving Your Own Equations," on page 30.

**Example: Price and Yield of a Discounted Note.** What are the price and yield of the following U.S. Treasury Bill: settlement date October 14, 2003; maturity date March 17, 2004; discount rate 8.7%? (Assume month/day/year format.)

Select the NOTE:PRICE equation in the Solver.

Keys:	Display:	Description:
<p> <input type="button" value="CALC"/>            10.142003  <input type="button" value="SETT"/>            3.172004  <input type="button" value="MAT"/>            8.7 <input type="button" value="DISC"/>            100 <input type="button" value="RV"/>  <input type="button" value="PRICE"/>  <input type="button" value="EXIT"/> <input type="button" value="▼"/> <input type="button" value="CALC"/>  <input type="button" value="YIELD"/> </p>	<p>           SETT=10.14            MAT=3.17            DISC=8.70            RV=100.00            PRICE=96.25            NOTE:YIELD=            (RV-PRICE) ...            YIELD=9.04         </p>	<p>           Creates menu.            Stores known values.            Calculates price.            Displays NOTE:YIELD equation, then its menu.            Calculates yield.         </p>

---

## Statistics

### Moving Average

Moving averages are often useful in predicting trends in data taken over a period of time. In moving-average calculations, a specified number of points is averaged. Each time a new point is acquired, the oldest point is discarded. Thus, the same number of points is used in each calculation.

## A Solver Equation for Moving Averages:

$$\text{MAVG} = \frac{\sum(I:\text{MAX}(1:\text{LAST}-N+1):\text{LAST}; 1:\text{ITEM}(\text{name}:I))}{\text{MIN}(N:\text{LAST})}$$

*N* = the number of values averaged in each calculation.

*LAST* = the item number of the most recent value to be averaged.

*name* = the name of the SUM list whose data will be averaged. When you create and name the SUM list, make sure its name matches the *name* in the Solver equation.

The following example assumes that you have entered the equation MAVG into the Solver, using VOL for the SUM list's name. For instructions on entering Solver equations, see "Solving Your Own Equations," on page 30.

**Example: A Moving Average in Manufacturing.** Calculate a three-month moving average for the number of units manufactured during the first half of the year. Manufacturing volumes are:

January	February	March	April	May	June
4400	5360	2900	3670	4040	3200

### Keys:

SUM

### Display:

CLR DATA YES

or

GET \*NEW ITEM(1)=?

4400 INPUT

5360 INPUT

2900 INPUT

3670 INPUT

### Description:

Displays SUM menu and current list.

Clears current list or gets

a new one.

Enters data.

## 218 14: Additional Examples

4040   
 3200  ITEM(7)=?  
 TOTAL=23,570.00

Names the list VOL.

VOL  ITEM(7)=?

Displays the MAVG equation. Make sure name is VOL.

(use  and   
 if necessary)

Displays menu.

3  N=3.00

Stores number of points.

3   
 MAVG=4,220.00

Calculates average for months 1, 2, and 3.

4   
 MAVG=3,976.67

Calculates average for months 2, 3, and 4.

5   
 MAVG=3,536.67

Calculates average for months 3, 4, and 5.

6   
 MAVG=3,636.67

Calculates average for months 4, 5, and 6.

## Chi-Squared ( $\chi^2$ ) Statistics

The  $\chi^2$  statistic is a measure of the goodness of fit between data and an assumed distribution.\* It is used to test whether a set of observed frequencies differs from a set of expected frequencies sufficiently to reject the hypothesis under which the expected frequencies were obtained.

\* The statistic can be assumed to be  $\chi^2$  distributed with  $n-1$  degrees of freedom if  $n$  or some of the  $E_i$  values are large.

In other words, it tests whether discrepancies between the observed frequencies ( $O_i$ ) and the expected frequencies ( $E_i$ ) are significant, or whether they might reasonably result from chance. The equation is:

$$\chi^2 = \sum_{i=1}^n \frac{(O_i - E_i)^2}{E_i}$$

If there is a close agreement between the observed and expected frequencies,  $\chi^2$  will be small. If the agreement is poor,  $\chi^2$  will be large.

### Solver Equations for $\chi^2$ Calculations:

#### If the expected value is a constant:

```
CHI=Σ(I:1:SIZES(name1):1:(ITEM(name1:I)
-EXP)^2÷EXP)
```

#### If the expected values vary:

```
CHI2=Σ(I:1:SIZES(name1):1:(ITEM(name1:I)
-ITEM(name2:I))^2÷ITEM(name2:I))
```

(To enter the  $\Sigma$  character, press **WXYZ** **OTHER** **MORE**  **$\Sigma$**  .)

*CHI2* = the final  $\chi^2$  value for your data.

*name1* = the name of the SUM list that contains the *observed values*.

*name2* = the name of the SUM list that contains the *expected values*.

*EXP* = the expected value when it is a constant.

When you create and name the SUM list(s), make sure the name(s) match *name1* (and *name2*, if applicable) in the Solver equation.

To solve the equation, press **CHI2** once or twice (until you see the message CALCULATING...).

The following example assumes that you have entered the CHI equation into the Solver, using OBS for *name1*. For instructions on entering Solver equations, see "Solving Your Own Equations," on page 30.

**Example: Expected Throws of a Die.** To determine whether a suspect die is biased, you toss it 120 times and observe the following results. (The expected frequency is the same for each number,  $120 \div 6$ , or 20.)

## 220 14: Additional Examples

	Number	1	2	3	4	5	6
<b>Frequency Observed</b>		25	17	15	23	24	16

**Keystroke:**

SUM

CLR DATA YES

or

GET #NEW ITEM(1)=?

25 INPUT

17 INPUT

15 INPUT

23 INPUT

24 INPUT

16 INPUT

ITEM(7)=?

TOTAL=120.00

EXIT NAME

OBS INPUT ITEM(7)=?

EXIT SOLVE

(use  and   
if necessary )

CALC

20 EXP EXP=20.00

CHI CHI=5.00

**Description:**

Displays SUM menu and current list.

Clears current list or gets a new one.

Enters observed values.

Names the list OBS.

Displays the CHI equation. Make sure *name1* is OBS.

Displays menu.

Stores expected value.

Calculates  $\chi^2$ .

The number of degrees of freedom is  $(n-1)=5$ . Consult statistical tables to find  $\chi^2$  to a significance level of 0.05 with 5 degrees of freedom. The table shows that  $\chi^2_{0.05,5} = 11.07$ . Since the computed value (5.00) is less than 11.07, you can conclude that, to a 0.05 significance level (95% probability), the die is fair.

**14: Additional Examples 221**

# A

## Assistance, Batteries, Memory, and Service

---

### Obtaining Help in Operating the Calculator

Hewlett-Packard is committed to supporting users of HP calculators. You can obtain answers to your questions about using the calculator from our Calculator Support department.

We suggest reading “Answers to Common questions,” below, before contacting us. Past experience has shown that many of our customers have similar questions.

---

### Answers to Common Questions

**Q:** I’m not sure if the calculator is malfunctioning or if I’m doing something incorrectly. How can I determine if the calculator is operating properly?

**A:** Refer to page 232, which describes the diagnostic self-test.

**Q:** My arithmetic keys don’t work like I expect. I press 12  $\boxed{+}$  3  $\boxed{=}$  and get 3.00.

**A:** You may be in the wrong mode. Press  $\boxed{\text{MODES}}$   $\boxed{\text{ALG}}$  to set Algebraic mode.

**Q:** My numbers contain commas as decimal points. How do I restore the periods?

**A:** Press  $\boxed{\text{DSP}}$   $\boxed{\cdot}$ .

### 222 A: Assistance, Batteries, Memory, and Service

**Q:** How do I change the number of decimal places the calculator displays?

**A:** The procedure is described in “Decimal Places” on page 34.

**Q:** How do I clear all or portions of memory?

**A:**  CLR clears the calculator line.  CLR DATA clears the data lists or variables accessible from the current menu. Erasing the entire contents of memory is covered in “Erasing Continuous Memory” on page 230.

**Q:** Why am I getting the wrong answer using the TVM menu?

**A:** Be sure to enter a value for *all five TVM variables*, even if a value is zero (as *FV* is for a loan without a balloon). Clearing the variables before starting ( CLR DATA ) accomplishes the same thing. Check the appropriate payment mode (mortgages and loans are typically End mode calculations), and specify the number of payments per year (  P/YR ). Also check that all figures for money paid out are *negative* (the cash-flow sign convention).

**Q:** Can I access the TVM menu functions from the Solver?

**A:** No, but you can do the same functions by copying the appropriate financial formulas into the Solver. The formulas are given starting on page 168.

**Q:** Can I access the data stored in my CFLO and SUM lists from the Solver?

**A:** Yes. See “Accessing CFLO and SUM Lists from the Solver,” page 177.

**Q:** How do I indicate multiplication in an equation typed into the Solver?

**A:** Use the multiplication key ( X ). You cannot use the letter  X in the ALPHA menu.


**Q:** What does an “E” in a number (for example, 2.51E–13) mean?




**A:** *Exponent* of ten (for example,  $2.51 \times 10^{-13}$ ). Refer to “Scientific Notation” on page 47.

**Q:** The calculator has displayed the message  
INSUFFICIENT MEMORY. What should I do?

## **A: Assistance, Batteries, Memory, and Service 223**

**A:** Refer to “Managing Calculator Memory” on page 227 for instructions on how to reclaim memory for your use.



**Q:** The calculator is operating slowly, and the  annunciator is blinking. Why?

**A:** The calculator is trace printing. Press  **PRINTER**  **TRACE**  **EXIT** to turn off tracing.




**Q:** How can I change the sign of a number in a list without keying in the number again?

**A:** Press  **RCL**  **INPUT**  **+/-**  **INPUT** .

**Q:** The beeper is not working.

**A:** Check the beeper mode by pressing  **MODES**  **BEEP** . See also page 36.

**Q:** The messages and the menu labels in the display are not in English. How do I restore the English?

**A:** Models of the HP 17bII+ sold in many countries outside of the United States include a menu to select the language for messages and labels. To select the English language, press  **MODES**  **INTL**  **ENGL** .

---


## Power and Batteries

The calculator is powered by two 3-volt lithium coin batteries.

When changing batteries, use only fresh button-cell batteries. Both batteries must be changed at the same time.

*Do not use rechargeable batteries.*

## Low-Power Indications

When the low-battery annunciator (  ) comes on, the calculator can continue normal operation for several hours. If the calculator is turned off, Continuous Memory will be preserved for approximately two weeks. To conserve battery power, printing does not function when the battery annunciator is on. Printing might halt during a printing operation.

## 224 A: Assistance, Batteries, Memory, and Service



due to a borderline low-battery condition. The calculator can detect that there is insufficient power for printing before the battery annunciator comes on.

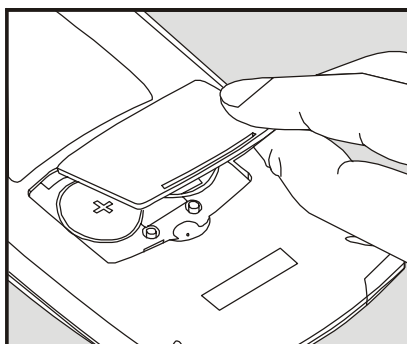
If you continue to use the calculator after the battery annunciator comes on, power can eventually drop to a level at which the calculator stops powering the display and keyboard. The calculator will require fresh batteries before it can be turned back on. When you turn the calculator on after fresh batteries have been installed, the calculator displays **MACHINE RESET** if your stored data is intact. If data has been lost, the calculator displays **MEMORY LOST**. In either case, the clock's time might be incorrect.

## Installing Batteries

**Once the batteries are removed, you must replace the batteries within 30 seconds to prevent loss of Continuous Memory.**

To install batteries:

1. Have two fresh CR2032 batteries at hand. Hold batteries by the edges. Do not touch the contacts. Wipe each battery with a clean, lint-free cloth to remove dirt and oil.
2. Make sure the calculator is *off*. **Do not press  again until the entire procedure for changing batteries is completed. Changing batteries with the calculator on can erase the contents of Continuous Memory.** If you have set any appointments, make sure they will not come due while the batteries are out.
3. Turn the calculator over and prize off the battery cover.



- 4. Never remove two old batteries at the same time, in case memory lost.** Remove one of the two batteries once. Insert a new battery, making sure that the positive sign (+) is facing outward.



---

**Do not mutilate, puncture, or dispose of batteries in fire. The batteries can burst or explode, releasing hazardous chemicals.**

### Warning

---

- 5.** Remove and insert the other battery as step 4. Make sure that the positive sign (+) on each battery is facing outward.
- 6.** Replace the battery compartment cover.
- 7.** Press on.

Now turn the calculator back on. If it does not function, you might have taken too long to change the batteries or inadvertently turned the calculator on while the batteries were out. *Remove the batteries* again and lightly press a coin against both battery contacts in the calculator *for a few seconds*. Put the batteries back in and turn the calculator on. You should see **MEMORY LOST**.

## 226 A: Assistance, Batteries, Memory, and Service

---

## Managing Calculator Memory

The calculator has approximately 30,740 units (or “bytes”) of *user* memory available. (This is separate from the *system* memory that stores all the unerasable information with which the calculator is manufactured.)

The calculator displays **INSUFFICIENT MEMORY** if you attempt an operation that uses more memory than is currently available. If you see this message:

1. Complete any calculations in the calculator line (press  $\square$  or  $\square$  **CLR**). This frees the memory that was being used to store each of the numbers and operators.
2. To further increase the amount of available memory:  
Rename the named SUM and CFLO lists with shorter names (see page 98), and clear any lists you no longer need (see page 99).
  - Shorten or delete any messages with appointments (see page 146).
  - Delete any Solver variables or equations you no longer need (see page 164).

---

## Resetting the Calculator

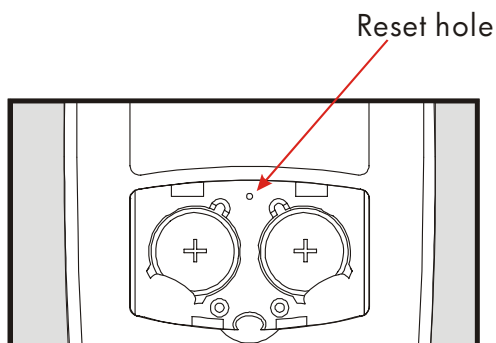
If the calculator doesn't respond to keystrokes or is behaving unusually, attempt to reset it. Resetting the calculator halts the current calculation, clears the calculator line, and displays the MAIN menu. Stored data remains intact except setting those conditions: double-space printing off, printer tracing off, printer without the ac adapter, and beeper on.

To reset the calculator, hold down **CLR** while pressing the third menu key from the left. Repeat if necessary. The calculator displays **MACHINE RESET** to confirm that reset has occurred.

The calculator can reset itself if it is dropped or if power is interrupted.

If the calculator still does not respond to keystrokes, use the following procedures.

1. Use a thin, pointed object to press the reset hole near of the battery compartment.



2. The calculator displays the INTL (international) menu. You must specify a language before proceeding (see page 18 for information about the setting the language).
3. The display will show **MEMORY LOST**. Pressing any key will clear this message from the display.

## 228 A: Assistance, Batteries, Memory, and Service

**For selecting English language:**

- ALG mode
- Month/day/year date format, 12-hour clock
- 2 decimal places, period (.) decimal point
- Double-space printing off, printer tracing off, printer without the ac adapter
- Beeper on
- APPT default time 00.00.00 12:00A, default time WED 01.01.03 12:00:00A
- Erased Continuous Memory
- U.S Dollars and EURO Dollars currencies and the rate equals 1.0000.

### **For selecting the other languages:**

- ALG mode
- Day/month/year date format, 24-hour clock
- 2 decimal places, comma (,) decimal point
- Double-space printing off, printer tracing off, printer without the ac adapter
- Beeper on
- APPT default time 00.00.00 00:00, default time WED 01.01.03 00:00:00
- Erased Continuous Memory
- U.S Dollars and EURO Dollars currencies and the rate equals 1.0000.

---

## **Erasing Continuous Memory**

Erasing Continuous Memory is a way of freeing a large amount of memory so that you can use it for other things. In addition, the calculator is set to certain "default" settings.

- Clears the calculator line and history stack.
- Deletes all Solver equations and their variables, and clears all other variables in menus.
- Clears all CFLO and SUM lists and their names.
- Clears all appointments.
- Returns U.S Dollars and EURO Dollars currencies and the rate equals 1.0000.
- Sets those conditions:

### **For English language:**

Month/day/year date format, 12-hour clock, 2 decimal places, period (.) decimal point, double-space printing off, printer tracing off, printer without the ac adapter, and beeper on.

### **For the other languages:**

Day/month/year date format, 24-hour clock, 2 decimal places, comma (,) decimal point, double-space printing off, printer tracing off, printer without the ac adapter, and beeper on.

## **230 A: Assistance, Batteries, Memory, and Service**

- Maintains the selected mode – ALG or RPN.

Erasing Continuous Memory does not affect the current time and date, date and the selected language.

To erase Continuous Memory, press and hold down **[CLR]**, the leftmost menu key, and the rightmost menu key. (Press three keys simultaneously). When the three keys are released, the calculator displays **MEMORY LOST**.

Continuous Memory can inadvertently be erased if the calculator is dropped or if power is interrupted.

---

## Clock Accuracy

The clock is regulated by a quartz crystal accurate to within 1.5 minutes per month under normal conditions. The accuracy of the clock crystal is affected by temperature, physical shock, humidity, and aging. Optimum accuracy is maintained at 25°C (77°F).

---

## Environmental Limits

In order to maintain product reliability, observe the following limits:

- Operating temperature: 0° to 45°C (32° to 113°F).
- Storage temperature: –20° to 65°C (–4° to 149°F).
- Operating and storage humidity: 90% relative humidity at 40°C (104°F) maximum.

---

## Determining If the Calculator Requires Service

Use these guidelines to determine if the calculator requires service. If it does, read “Service” on page 235.

■ **If the calculator won't turn on:**

1. Attempt to reset the calculator (see page 228).
2. If the calculator fails to respond after step 1, replace the batteries (see page 225). *If you have just replaced the batteries, see page 227.*

If these steps do not help, the calculator requires service.

■ **If the calculator doesn't respond to keystrokes:**

1. Attempt to reset the calculator (see page 228).
2. If the calculator still fails to respond, attempt to erase Continuous Memory (see page 230). This will erase all the information you've stored.

If these steps do not help, the calculator requires service.

■ **If the calculator responds to keystrokes but you suspect that it is malfunctioning:**

1. Do the self-test (described below). If the calculator fails the self test, it requires service.
2. If the calculator passes the self-test, it is quite likely you've made a mistake in operating the calculator. Try rereading portions of the manual, and check "Answers to Common Questions" on page 222.
3. Contact the Calculator Support department.

---

## **Confirming Calculator Operation: Self-Test**

If the display can be turned on, but it appears that the calculator is not operating properly, you can do a diagnostic self-test. The self-test runs continuously, repeating until you halt it.


To run the self-test:

1. Turn the calculator on.
2. If you have the optional infrared printer, turn it on. Certain diagnostic

### **232 A: Assistance, Batteries, Memory, and Service**



information is printed during the test.

3. If possible, return to the MAIN menu (press  **MAIN**).
4. To start the self-test, hold down **CLR** while you press the fifth menu key from the left. Once the self-test has begun, do not press any keys until you are ready to halt the test.
5. During the test, the calculator beeps periodically and displays various patterns and characters. Watch for one of two messages that are displayed before the test automatically repeats:
  - If the calculator passes the self-test, the calculator displays **OK 17BII+**
  - If the calculator displays **FAIL** followed by a five-digit number, the calculator requires service.
6. To halt the self-test, hold down **CLR** while you press the third menu key from the left. The calculator displays **MACHINE RESET**. If you press any other key instead, the test halts and the calculator displays a **FAIL** message. *This results from an incorrect key being pressed, and does not mean that the calculator requires service.*
7. If the calculator failed the self-test, repeat steps 4 through 6 to verify the results. If you do not have a printer, write down the messages that are displayed in step 5.

---

## Warranty

HP 17bII+ Financial Calculator; Warranty period: 12 months

1. HP warrants to you, the end-user customer, that HP hardware, accessories and supplies will be free from defects in materials and workmanship after the date of purchase, for the period specified above. If HP receives notice of such defects during the warranty period, HP will, at its option, either repair or replace products which prove to be defective. Replacement products may be either new or like-new.
2. HP warrants to you that HP software will not fail to execute its programming instructions after the date of purchase, for the period specified above, due to defects in material and

workmanship when properly installed and used. If HP receives notice of such defects during the warranty period, HP will replace software media which does not execute its programming instructions due to such defects.

3. HP does not warrant that the operation of HP products will be uninterrupted or error free. If HP is unable, within a reasonable time, to repair or replace any product to a condition as warranted, you will be entitled to a refund of the purchase price upon prompt return of the product.
4. HP products may contain remanufactured parts equivalent to new in performance or may have been subject to incidental use.
5. Warranty does not apply to defects resulting from (a) improper or inadequate maintenance or calibration, (b) software, interfacing, parts or supplies not supplied by HP, (c) unauthorized modification or misuse, (d) operation outside of the published environmental specifications for the product, or (e) improper site preparation or maintenance.
6. HP MAKES NO OTHER EXPRESS WARRANTY OR CONDITION WHETHER WRITTEN OR ORAL. TO THE EXTENT ALLOWED BY LOCAL LAW, ANY IMPLIED WARRANTY OR CONDITION OF MERCHANTABILITY, SATISFACTORY QUALITY, OR FITNESS FOR A PARTICULAR PURPOSE IS LIMITED TO THE DURATION OF THE EXPRESS WARRANTY SET FORTH ABOVE. Some countries, states or provinces do not allow limitations on the duration of an implied warranty, so the above limitation or exclusion might not apply to you. This warranty gives you specific legal rights and you might also have other rights that vary from country to country, state to state, or province to province.
7. TO THE EXTENT ALLOWED BY LOCAL LAW, THE REMEDIES IN THIS WARRANTY STATEMENT ARE YOUR SOLE AND EXCLUSIVE REMEDIES. EXCEPT AS INDICATED ABOVE, IN NO EVENT WILL HP OR ITS SUPPLIERS BE LIABLE FOR LOSS OF DATA OR FOR DIRECT, SPECIAL, INCIDENTAL, CONSEQUENTIAL (INCLUDING LOST PROFIT OR DATA), OR OTHER DAMAGE, WHETHER BASED IN CONTRACT, TORT, OR OTHERWISE. Some countries, States or provinces do not allow the exclusion or limitation of incidental or consequential damages, so the above limitation or exclusion may not apply to you.
8. The only warranties for HP products and services are set forth in

## **234 A: Assistance, Batteries, Memory, and Service**

the express warranty statements accompanying such products and services . Nothing herein should be construed as constituting an additional warranty.HP shall not be liable for technical or editorial errors or omissions contained herein.

**FOR CONSUMER TRANSACTIONS IN AUSTRALIA AND NEW ZEALAND: THE WARRANTY TERMS CONTAINED IN THIS STATEMENT, EXCEPT TO THE EXTENT LAWFULLY PERMITTED, DO NOT EXCLUDE, RESTRICT OR MODIFY AND ARE IN ADDITION TO THE MANDATORY STATUTORY RIGHTS APPLICABLE TO THE SALE OF THIS PRODUCT TO YOU.**

---

## Service

Europe	Country :	Telephone numbers
	Austria	+43-1-3602771 203
	Belgium	+32-2-7126219
	Denmark	+45-8-2332844
	Eastern Europe countries	+420-5-41422523
	Finland	+35-89640009
	France	+33-1-49939006
	Germany	+49-69-95307103
	Greece	+420-5-41422523
	Holland	+31-2-06545301
	Italy	+39-0422-303069
	Norway	+47-63849309
	Portugal	+351-213-180020
	Spain	+34-917-820111
	Sweden	+46-851992065
	Switzerland	+41-1-4395358 (German) +41-22-8278780 (French) +39-0422-303069 (Italian)
	Turkey	+420-5-41422523
	UK	+44-207-4580161
	Czech Republic	+420-5-41422523
	South Africa	+27-11-541 9573
	Luxembourg	+32-2-7126219

<b>Asia Pacific</b>	Other European countries	+420-5-41422523
	<b>Country :</b>	<b>Telephone numbers</b>
	Australia	+61-3-9841-5211
	Singapore	+61-3-9841-5211

<b>L.America</b>	<b>Country :</b>	<b>Telephone numbers</b>
	Argentina	0-810-555-5520
		Sao Paulo 3747-7799; ROTC
	Brazil	0-800-157751
		Mx City 5258-9922; ROTC
	Mexico	01-800-472-6684
	Venezuela	0800-4746-8368
	Chile	800-360999
	Columbia	9-800-114726
	Peru	0-800-10111
	Central America & Caribbean	1-800-711-2884
	Guatemala	1-800-999-5105
	Puerto Rico	1-877-232-0589
Costa Rica	0-800-011-0524	

<b>N.America</b>	<b>Country :</b>	<b>Telephone numbers</b>
	U.S.	1800-HP INVENT
	Canada	(905)206-4663 or 800-HP INVENT

ROTC = Rest of the country

---

## Regulatory information

This section contains information that shows how the HP 17bII+ Financial calculator complies with regulations in certain regions. Any modifications to the calculator not expressly approved by Hewlett-Packard could void the authority to operate the 17bII+ in these regions.

### 236 A: Assistance, Batteries, Memory, and Service

## USA

This calculator generates, uses, and can radiate radio frequency energy and may interfere with radio and television reception. The calculator complies with the limits for a Class B digital device, pursuant to Part 15 of the FCC Rules. These limits are designed to provide reasonable protection against harmful interference in a residential installation.

However, there is no guarantee that interference will not occur in a particular installation. In the unlikely event that there is interference to radio or television reception (which can be determined by turning the calculator off and on), the user is encouraged to try to correct the interference by one or more of the following measures:

- Reorient or relocate the receiving antenna.
- Relocate the calculator, with respect to the receiver.

## Canada

This Class B digital apparatus complies with Canadian ICES-003.

Cet appareil numérique de la classe B est conforme à la norme NMB-003 du Canada.

## Japan

この装置は、情報処理装置等電波障害自主規制協議会(VCCI)の基準に基づく第二情報技術装置です。この装置は、家庭環境で使用することを目的としていますが、この装置がラジオやテレビジョン受信機に近接して使用されると、受信障害を引き起こすことがあります。

取扱説明書に従って正しい取り扱いをしてください。

---

## Noise Declaration

In the operator position under normal operation (per ISO 7779): LpA < 70dB.

# B

## More About Calculations

---

### IRR% Calculations

The calculator determines *IRR%* for a set of cash flows using mathematical formulas that “search” for the answer. The process finds a solution by estimating an answer and then using that estimate to do another calculation—in mathematical terms, this is called an iterative process.

In most cases, the calculator finds the desired answer, since there is usually only one solution to the calculation. However, calculating *IRR%* for certain sets of cash flows is more complex. There may be more than one mathematical solution to the problem, or there may be no solution. In these cases, the calculator displays a message to help you interpret what has happened.

### Possible Outcomes of Calculating IRR%

These are the possible outcomes of an *IRR%* calculation for which you have not stored a guess.

- **Case 1:** The calculator displays a positive answer. This is the only positive answer. However, one or more negative answers may exist.
- **Case 2:** The calculator finds a negative answer but a single positive solution also exists. It displays:

```
IRR%>0 EXISTS; KEY  
IN GUESS; [STO] (IRR%)
```

To see the negative answer, press  $\blacktriangleleft$ . To search for that positive answer, you must input a guess. (Refer to “Storing a Guess for *IRR%*”; below). There might also be additional negative answers.

- **Case 3:** The calculator displays a negative answer and no message.

### 238 B: More About Calculations

This is the only answer.

- **Case 4:** The calculator displays the message:

```
MANY/NO SOLUTIONS; KEY  
IN GUESS; [STO] {IRR%}
```

The calculation is very complex. It might involve more than one positive or negative answer, or there may be no solution. To continue the calculation, you must store a guess.

- **Case 5:** The calculator displays: `NO SOLUTION`

There is no answer. This situation might be the result of an error, such as a mistake in keying in the cash flows. A common mistake is to put the wrong sign for a cash flow. A valid cash flow series must have at least one positive *and* one negative cash flow.

## Halting and Restarting the IRR% Calculation

The search for *IRR%* may take a relatively long time. You can halt the calculation at any time by pressing any key. The calculator then displays the current estimate for *IRR%*. You can resume the calculation by:

- Pressing `[STO]` `IRR%` while the current estimate is displayed in the calculator line. This continues the calculation from where it left off.
- Storing a guess for *IRR%*, discussed below.

## Storing a Guess for IRR%

To enter a guess, key in an estimate of *IRR%* and then press `[STO]` `IRR%`.

You can enter a guess for *IRR%* at these times:

- Before beginning the calculation. This can reduce the time required to calculate an answer.
- After you've halted the calculation.
- After the calculator has halted the calculation due to any of the above cases. For cases 3 and 5, however, no (other) solutions will be found.

When calculating *IRR%* using a guess, the calculator displays the current estimate of *IRR%* and the calculated value of *NPV* for each iteration. The calculation halts when the calculator finds an answer. However, there

may be additional positive or negative answers, or no true solution at all. You can continue searching for other solutions by halting the calculation and entering a different guess.

One way to obtain a good guess for *IRR%* is to calculate *NPV* for various interest rates (*I%*). Since *IRR%* is the interest rate at which *NPV* equals zero, the best estimate of *IRR%* is the interest rate that yields the value for *NPV* closest to zero.

To find a good estimate for *IRR%*, key in a guess for *IRR%* and press **I%**. Then, press **NPV** to calculate *NPV* for that value. Repeat the calculation of *NPV* for several values of *I%*, and look for trends in the results. Choose as your guess for *IRR%* a value of *I%* that produces an *NPV* close to zero.

---

## Solver Calculations

As noted in chapter 12, the Solver uses two methods to find solutions, depending on the complexity of the equation: *direct* and *iterative* (an indirect). To use all the calculating power included in the Solver, it would help to understand, in a general way, how it works.

### Direct Solutions

When you start a calculation (by pressing a menu key), the Solver first tries to find a *direct* solution by “isolating” the variable you are solving for (the *unknown*). Isolating a variable involves rearranging the equation so that the unknown variable is by itself on the left-hand side of the equation. For example, suppose you enter the equation:

$$PROFIT = PRICE - COST$$

If you’ve stored values for *PROFIT* and *PRICE*, pressing **COST** causes the Solver to internally rearrange the equation algebraically to solve for *COST* (*COST* is the unknown):

$$COST = PRICE - PROFIT$$

Answers calculated this way are called direct solutions.

## 240 B: More About Calculations



For certain equations, the unknown can be isolated, but an answer cannot be calculated with the values stored. Then the calculator displays: **SOLUTION NOT FOUND**

For example, if you enter an equation:

$$AREA = L \times W$$

and then enter values for *AREA* and *W*, the Solver rearranges the equation to:

$$L = AREA \div W$$

in order to calculate *L*. However, if you enter the value zero for *W*, the Solver cannot find an answer because division by zero is not allowed.

The Solver can isolate the unknown variable if the equation meets these conditions:

- The unknown variable occurs only once in the equation.\*
- The only functions in which the unknown variable appears are ALOG, DATE, DDAYS (actual calendar only), EXP, EXPM1, IF (in *then* and *else* clauses only), INV, LN, LNP1, LOG, S, SQ, and SQRT.
- The only operators involving the unknown variable are +, -, x, ÷, and ^ (power). If you are solving for a variable raised to a positive, even power (for example,  $A^2 = 4$ ), there may be more than one solution. However, if the Solver can isolate the variable, it will find *one* of the solutions using the positive root. For example, the Solver rearranges  $A^2 = 4$  to  $A = \sqrt{4}$  and calculates the answer + 2.†
- The unknown variable does not appear as an exponent.

\* Exceptions: (1) Occurrences of the unknown variable as the argument of the S function are ignored. (2) The unknown variable can appear twice within an IF function: once in the *then* clause and once in the *else* clause.

† The Solver's ability to find a solution iteratively can often be enhanced by rewriting the equation so that the unknown variable does not appear as a divisor. For example, the Solver may more easily solve for *A* if the equation  $1 \div (A^2 - A) = B$  is rewritten as  $(A^2 - A) \times B = 1$ .

## B: More About Calculations 241

## Iterative Solutions

If the Solver is not able to isolate the unknown variable, it cannot provide a direct solution. In these cases, the Solver searches iteratively for a solution.\*

In its iterative search for a solution, the Solver looks for a value that sets the left side of the equation equal to the right side. To do this, the Solver starts with two initial estimates of the answer, which we'll call estimate #1 and estimate #2. Using estimate #1, the Solver calculates values for the left and right side of the equation (*LEFT* and *RIGHT*) and calculates *LEFT* minus *RIGHT* (*LEFT* – *RIGHT*). Then, the Solver does the same calculations for estimate #2. If neither estimate produces a value of zero for *LEFT* – *RIGHT*, the Solver analyzes the results and produces two new estimates that it judges to be closer to the answer. By repeating this process many times, the Solver narrows in on the answer. During this search, the calculator displays the two current estimates and the sign of (*LEFT* – *RIGHT*) for each estimate, as shown.



The image shows a calculator display with two lines of text. The first line is "AP1:25.0000000000" followed by a minus sign "-". The second line is "AP1:0.01384615385" followed by a plus sign "+". Two red arrows point from the right side of the display to the minus and plus signs respectively.

Sign of *LEFT* – *RIGHT* for each estimate

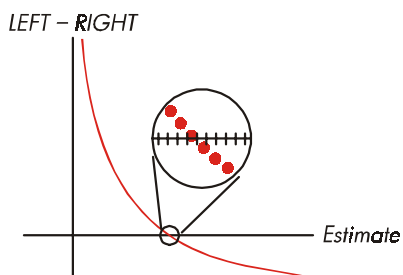
Since calculators cannot do calculations with infinite precision (the HP 17bII+ uses 12 digits in its calculations), sometimes the Solver will be unable to find an estimate where *LEFT* – *RIGHT* is exactly zero. However, the Solver can distinguish between situations where the current estimate *could* be a solution, and situations where no solution is found.

\* Exceptions: (1) Occurrences of the unknown variable as the argument of the *S* function are ignored. (2) The unknown variable can appear twice within an *IF* function: once in the *then* clause and once in the *else* clause.

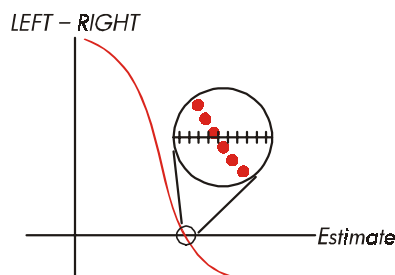
## 242 B: More About Calculations

The iterative search for a solution sometimes takes several minutes. (You can halt the search at any time by pressing any key except  $\square$ .) There are four possible outcomes:

- **Case 1:** The calculator displays an answer. This is very likely the true solution for the unknown variable. There are two situations in which the Solver returns a case 1 answer:
  - **Case 1a:**  $LEFT - RIGHT$  is exactly zero.
  - **Case 1b:**  $LEFT - RIGHT$  is not zero for either estimate. However, the Solver has found two estimates that cannot get any closer together. (Numbers that are as close together as possible are called *neighbors*.) Furthermore,  $LEFT - RIGHT$  is a positive value for one estimate and a negative value for the other estimate.



Case 1a:  
 $LEFT - RIGHT$  is exactly 0.



Case 1b:  
 $LEFT - RIGHT$  is not exactly 0.  
 $LEFT$  and  $RIGHT$  are relatively close together. The two estimates are "neighbors".

If you want to know whether  $LEFT - RIGHT$  is *exactly* zero, press the menu key for the unknown variable. If  $LEFT - RIGHT$  is *not* equal to zero, the calculator displays the values of  $LEFT$  and  $RIGHT$ .

```

LEFT : 0.000000000000
RIGHT: 1.000000000000
  
```

The equation could have more than one iterative solution. If the answer does not seem reasonable, enter one or two guesses and

restart the search.

- **Case 2:** The calculator displays the values of *LEFT* and *RIGHT*, which are unequal. To see the calculator's result, press  $\blacktriangleleft$  or  $\boxed{\text{CLR}}$ . If *LEFT* and *RIGHT* are relatively close to one another in value, the result is probably a true solution. Otherwise, the result is probably not a true solution.

If the result seems unreasonable, it could be because the equation has more than one solution. You might want to enter one or two guesses and restart the search.

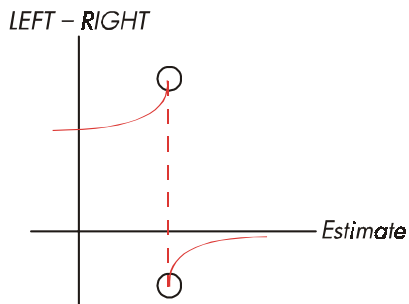
If you want to obtain additional information about the answer, press and hold down the menu key for the unknown variable until the numbers in the display stop changing. At this point, the Solver is displaying the final estimates and the signs of *LEFT*–*RIGHT* for each estimate.

AP1:1.79458049434	-
AP1:1.79458049433	+

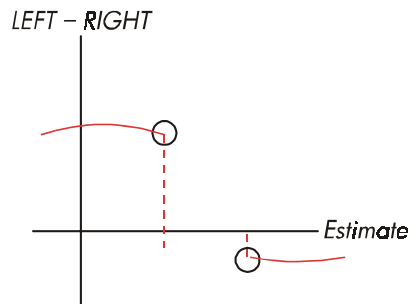
This information can be helpful:

- **Case 2a:** If the signs of *LEFT*–*RIGHT* are opposite, and the two estimates are as close together as two 12-digit numbers can get (neighbors), the Solver found two estimates that “bracket” an ideal solution (a solution where *LEFT*–*RIGHT* equals zero). If *LEFT* and *RIGHT* are relatively close together, the answer is probably a solution.
- **Case 2b:** If the signs of *LEFT*–*RIGHT* are opposite, and the two estimates are not neighbors, be very cautious about accepting the answer as a solution. If *LEFT* and *RIGHT* are relatively close together, the answer is probably a solution.
- **Case 2c:** If *LEFT*–*RIGHT* for the two estimates have the same sign, the Solver has halted because it could find no estimates that further reduced the magnitude of *LEFT*–*RIGHT*. Be very cautious about accepting the answer. If the values of *LEFT* and *RIGHT* are not relatively close to one another, you should reject the answer.

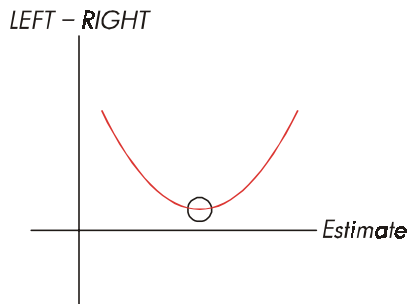
## 244 B: More About Calculations



Case 2a:  
 $LEFT - RIGHT$  have opposite signs. The two estimates are "neighbors".



Case 2b:  
 $LEFT - RIGHT$  have opposite signs. The two estimates are far apart.



Case 2c:  
 $LEFT - RIGHT$  have the same sign..

■ **Case 3:** The calculator displays:

BAD GUESSES :  
 PRESS [CLR] TO VIEW

The Solver is unable to begin its iterative search for a solution using the current initial estimates (guesses). You might find a solution by

entering different estimates. The closer you can estimate the answer, the more likely that the Solver will find a solution.

■ **Case 4:** The calculator displays: **SOLUTION NOT FOUND**

The Solver is unable to find a solution. Check your equation to make sure you have made no errors in entering it. Also check the value of each known variable. If your equation and variables are correct, you might be able to find a solution by entering very good guesses.

---

## Equations Used by Built-in Menus

### Actuarial Functions

$n$  = number of compounding periods.

$i\%$  = periodic interest rate, expressed as a percentage.

Single Payment Present Value Function

(Present value of a single \$1.00 payment made after  $n$  periods.)

$$SPPV (i\% : n) = \left(1 + \frac{i\%}{100}\right)^{-n}$$

Single Payment Future Value Function

(Future value after  $n$  periods of a single \$1.00 payment.)

$$SPFV (i\% : n) = \left(1 + \frac{i\%}{100}\right)^n$$

Uniform Series Present Value Function

(Present value of a \$1.00 payment that occurs  $n$  times.)

$$USPV (i\% : n) = \frac{1 - \left(1 + \frac{i\%}{100}\right)^{-n}}{\frac{i\%}{100}}$$

Uniform Series Future Value Function

(Future value of a \$1.00 payment that occurs  $n$  times.)

## 246 B: More About Calculations

$$USFV (i\% : n) = \frac{\left(1 + \frac{i\%}{100}\right)^n - 1}{\frac{i\%}{100}}$$

### Percentage Calculations in Business (BUS)

$$\%CHANGE = \left(\frac{NEW - OLD}{OLD}\right) \times 100$$

$$\%TOTAL = \left(\frac{PART}{TOTAL}\right) \times 100$$

$$MARKUP\%C = \left(\frac{PRICE - COST}{COST}\right) \times 100$$

$$MARKUP\%P = \left(\frac{PRICE - COST}{PRICE}\right) \times 100$$

### Time Value of Money (TVM)

S = payment mode factor (0 for End mode; 1 for Begin mode).

$$i\% = \frac{I\%YR}{P/YR}$$

$$0 = PV + \left(1 + \frac{i\% \times S}{100}\right) \times PMT \times USPV(i\% : n) + FV \times SPPV(i\% : n)$$

### Amortization

$\Sigma INT$  = accumulated interest

$\Sigma PRIN$  = accumulated principal

$i$  = periodic interest rate

BAL is initially PV rounded to the current display setting.

PMT is initially PMT rounded to the current display setting.

$$i = \frac{I\%YR}{P/YR \times 100}$$

For each payment amortized:

$INT' = BAL \times i$  ( $INT'$  is rounded to the current display setting;

$INT' = 0$  for period 0 in Begin mode)

$INT = INT'$  (with sign of  $PMT$ )

$PRIN = PMT + INT'$

$PRIN = PMT + INT'$

$BAL_{new} = BAL_{old} + PRIN$

$\Sigma INT_{new} = \Sigma INT_{old} + INT$

$\Sigma PRIN_{new} = \Sigma PRIN_{old} + PRIN$

## Interest Rate Conversions

Periodic compounding

$$EFF\% = \left[ \left( 1 + \frac{NOM\%}{100 \times P} \right)^P - 1 \right] \times 100$$

Continuous compounding

$$EFF\% = \left( e^{\frac{NOM\%}{100}} - 1 \right) \times 100$$

## Cash-Flow Calculations

$j$  = the group number of the cash flow.

$CF_j$  = amount of the cash flow for group  $j$ .

$n_j$  = #TIMES the cash flow occurs for group  $j$ .

$k$  = the group number of the last group of cash flows.

$$N_j = \sum_{1 \leq l < j} n_l = \text{total number of cash flows prior to group } j$$

$$NPV = CF_0 + \sum_{j=1}^k (CF_j \times USPV(i\% : n_j) \times SPPV(i\% : N_j))$$

When  $NPV = 0$ , the solution for  $i\%$  is  $IRR\%$ .

## 248 B: More About Calculations



$$NFV = NPV \times SPFV(i\% : N) \text{ where } N = \sum_{j=1}^k n_j$$

$$NUS = \frac{NPV}{USPV(i\% : N)}$$

$$TOTAL = \sum_{j=0}^k (n_j \times CF_j)$$

## Bond Calculations

**Reference:** Lynch, John J., Jr. and Jan H. Mayle, *Standard Securities Calculation Methods*, Securities Industry Association, New York, 1986.

A=accrued days, the number of days from beginning of coupon period to settlement date.

E=number of days in coupon period bracketing settlement date. By convention, E is 180 (or 360) if calendar basis is 30/360.

DSC=number of days from settlement date to next coupon date. (DSC = E - A).

M=coupon periods per year ( 1 = annual, 2 = semiannual),

N=number of coupon periods between settlement and redemption dates.  
If N has a fractional part (settlement not on coupon date), then round it to the next higher whole number.

Y=annual yield as a decimal fraction, YLD% / 100.

For one or fewer coupon period to redemption:

$$PRICE = \left[ \frac{CALL + \frac{CPN\%}{M}}{1 + \left( \frac{DSC}{E} \times \frac{Y}{M} \right)} \right] - \left( \frac{A}{E} \times \frac{CPN\%}{M} \right)$$

For more than one coupon period to redemption:

$$PRICE = \left[ \frac{CALL}{\left(1 + \frac{Y}{M}\right)^{N-1 + \frac{DSC}{E}}} \right] + \left[ \sum_{K=1}^N \frac{\frac{CPN\%}{M}}{\left(1 + \frac{Y}{M}\right)^{K-1 + \frac{DSC}{E}}} \right] - \left( \frac{A}{E} \times \frac{CPN\%}{M} \right)$$

The “end-of-month” convention is used to determine coupon dates in the following exceptional situations. (This affects calculations for *YLD%*, *PRICE*, and *ACCRU*.)

- If the maturity date falls on the last day of the month, then the coupon payments will also fall on the last day of the month. For example, a semiannual bond that matures on September 30 will have coupon payment dates on March 31 and September 30.
- If the maturity date of a semiannual bond falls on August 29 or 30, then the February coupon payment dates will fall on the last day of February (28, or 29 in leap years).

## Depreciation Calculations

For the given year, *YR#*:

$$ACRS = \frac{ACRS\%}{100} \times BASIS$$

$$SL = \frac{BASIS - SALV}{LIFE}$$

$$SOYD = \frac{BASIS - SALV}{LIFE \times \frac{(LIFE + 1)}{2}} \times (LIFE - YR\# + 1)$$

$$DB = \frac{BASIS \times FACT\%/100}{LIFE} \times \left( 1 - \frac{(FACT\%/100)}{LIFE} \right)^{(YR\# - 1)}$$

## 250 B: More About Calculations

For the last year of depreciation, *DB* equals the remaining depreciable value for the prior year.

## Sum and Statistics

$n$  = number of items in the list.

$x'$  = an element of the sorted list.

$$TOTAL = \sum x_i \qquad MEAN = \bar{x} = \frac{\sum x_i}{n}$$

$$MEDIAN = x'_j \quad \text{for odd } n, \text{ where } j = \frac{n + 1}{2}$$

$$MEDIAN = \frac{(x'_j + x'_{j+1})}{2} \quad \text{for even } n, \text{ where } j = \frac{n}{2}$$

$$STDEV = \sqrt{\frac{\sum (x_i - \bar{x})^2}{n - 1}}$$

$$W.MN = \frac{\sum (y_i \cdot x_i)}{\sum y_i} \qquad G.SD = \sqrt{\frac{\sum y_i x_i^2 - (\sum y_i) \bar{x}^2}{(\sum y_i) - 1}}$$

$$RANGE = MAX - MIN$$

## Forecasting

	Model	Transformation	$X_i$	$Y_i$
LIN	$y = B + Mx$	$y = B + Mx$	$x_i$	$y_i$
EXP	$y = Be^{Mx}$	$\ln y = \ln B + Mx$	$x_i$	$\ln y_i$
LOG	$y = B + M \ln x$	$y = B + M \ln x$	$\ln x_i$	$y_i$
PWR	$y = Bx^M$	$\ln y = \ln B + M \ln x$	$\ln x_i$	$\ln y_i$

Let:  $\bar{X} = \frac{\sum X_i}{n}$        $\bar{Y} = \frac{\sum Y_i}{n}$

$SX^2 = \sum (X_i - \bar{X})^2$        $SY^2 = \sum (Y_i - \bar{Y})^2$

$SXY = \sum (X_i - \bar{X})(Y_i - \bar{Y})$

Then:  $M = \frac{SXY}{SX^2}$

$B = b$  for LIN and LOG models, and  
 $B = e^b$  for EXP and PWR models,

where  $b = \bar{Y} - M\bar{X}$

$$\text{CORR} = \frac{SXY}{\sqrt{SX^2 \times SY^2}}$$

## Equations Used in Chapter 14

### Canadian Mortgages

$$PV = -PMT \left[ \frac{1 - (1 + r)^{-N}}{r} \right] - FV (1 + r)^{-N}$$

where:  $r = \left[ \left( 1 + \frac{CI\%YR}{200} \right)^{\frac{1}{6}} - 1 \right]$

$N$  = total number of monthly payments  
 $CI\%YR$  = annual interest rate (as a percent)  
 $PV$  = loan amount  
 $PMT$  = monthly payment  
 $FV$  = balloon payment

## 252 B: More About Calculations

## Odd-Period Calculations

$$PV \left[ 1 + i \times \frac{DAYS}{30} \right] = - (1 + i \times S) \times PMT \times \left[ \frac{1 - (1 + i)^{-N}}{i} \right] - FV(1 + i)^{-N}$$

Where:  $PV$  = loan amount  
 $i$  = periodic interest rate as a decimal  
 $DAYS$  = actual number of days until the first payment  
 $PMT$  = periodic payment amount  
 $N$  = total number of payments  
 $FV$  = balloon payment amount  
 $S = 1$  if  $DAYS < 30$   
 $S = 0$  if  $DAYS \geq 30$

## Advance Payments

$$PMT = \frac{-PV - FV(1 + i)^{-N}}{\left[ \frac{1 - (1 + i)^{-(N - \#ADV)}}{i} + \#ADV \right]}$$

where:  $PMT$  = payment amount  
 $PV$  = loan amount  
 $FV$  = balloon payment amount  
 $i$  = periodic interest rate (as a decimal)  
 $N$  = total number of payments  
 $\#ADV$  = number of payments made in advance

## Modified Internal Rate of Return




$$MIRR = 100 \left[ \left( \frac{NFV_p}{-NPV_N} \right)^{1/n} - 1 \right]$$

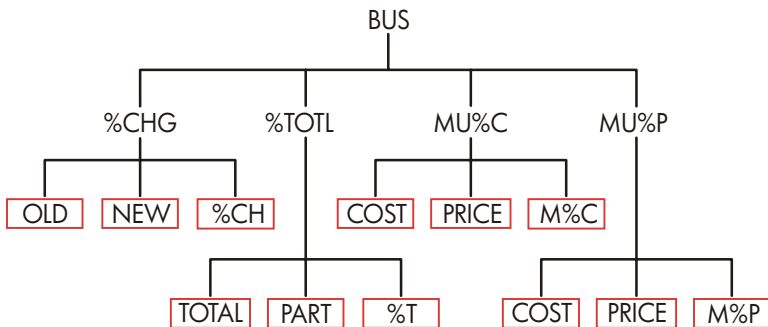
where:  $n$  = total number of compounding periods  
 $NFV_p$  = net future value of positive cash flows  
 $NPV_N$  = net present value of negative cash flows

# C

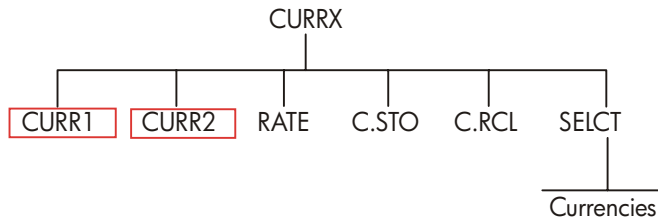
## Menu Maps

The following maps show how to display each of the menus. There is a map for each menu label in the MAIN menu and for each menu found on the keyboard. The menu labels for variables are enclosed in boxes to illustrate how they are used:

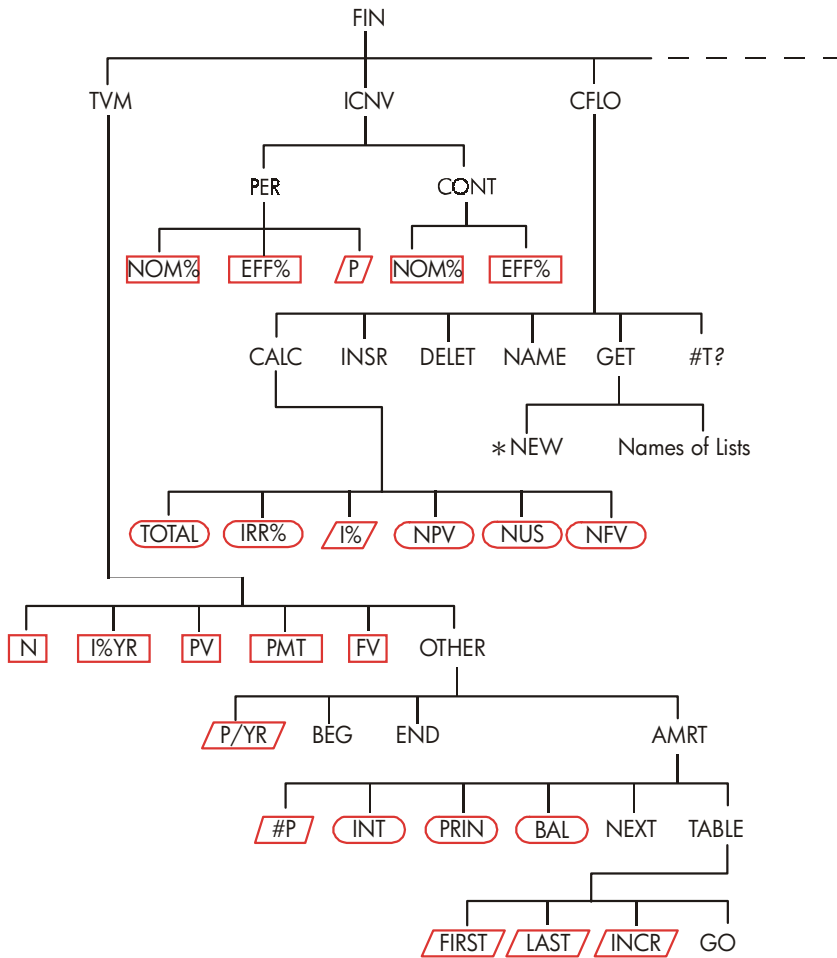
-  Variable used to store and calculate values.
-  Variable used to calculate or display values; cannot be used to store values.
-  Variable used to store values; cannot be used to calculate values.



**Figure C-1. BUS Menu**

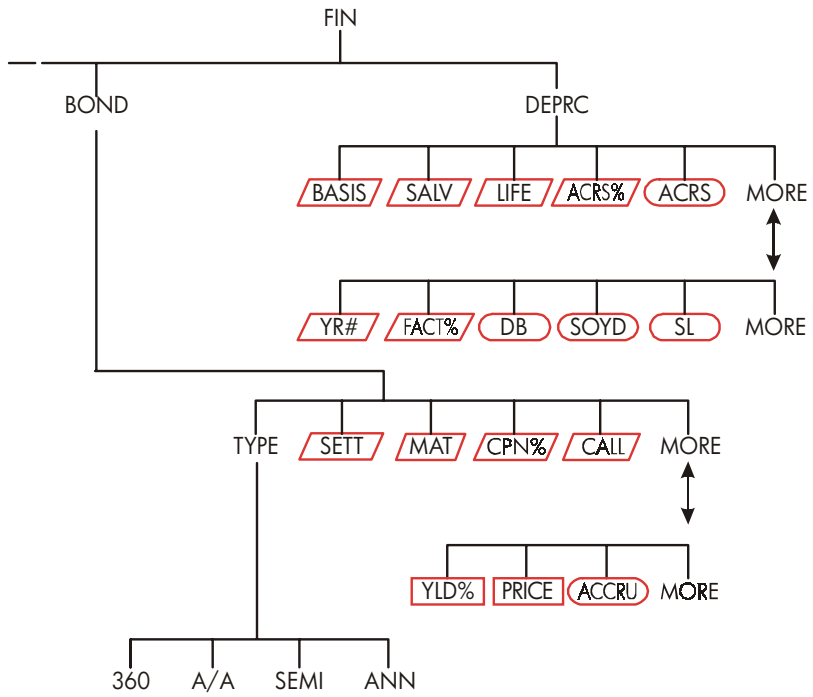


**Figure C-2. CURRX Menu**

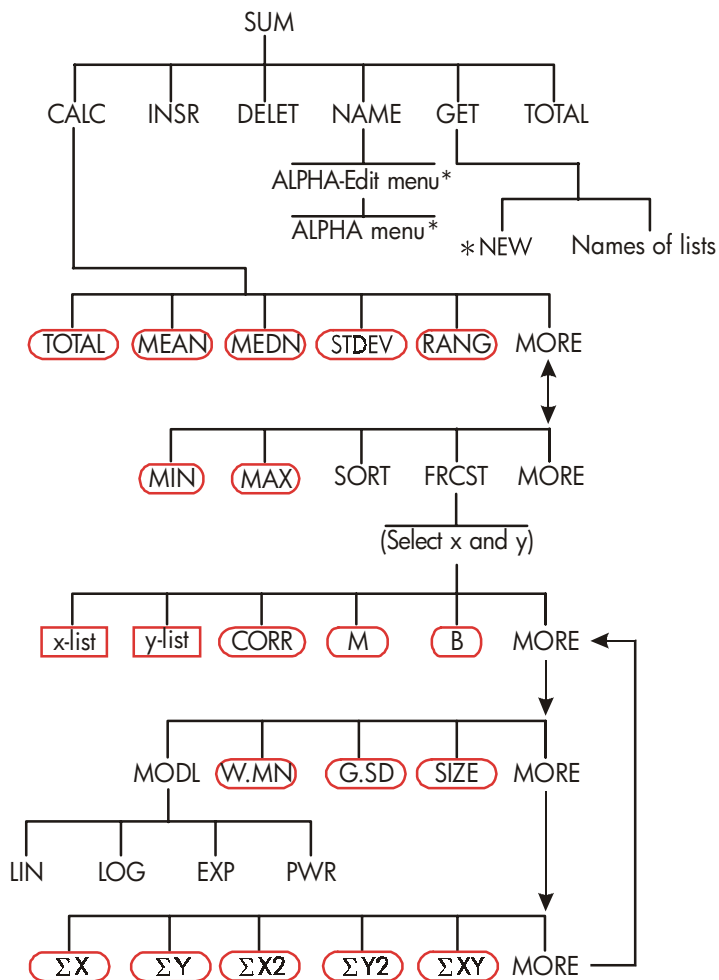


**Figure C-3. FIN Menu**





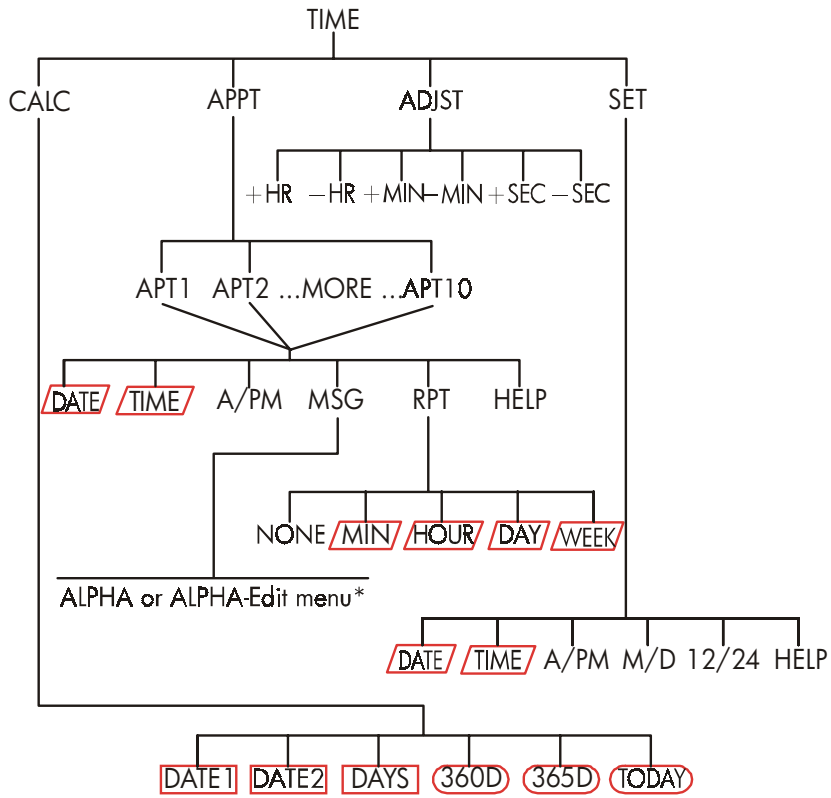
**Figure C-3 (continued). FIN Menu**



**Figure C-4. SUM Menu**

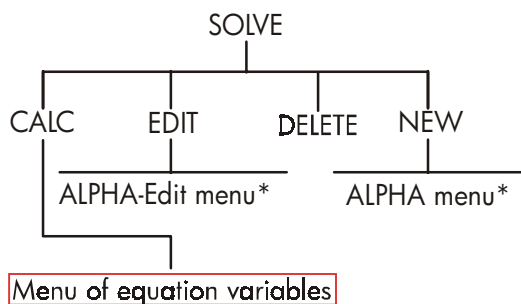
\* For the complete menu, see pages 30-31.

## 258 C: Menu Maps

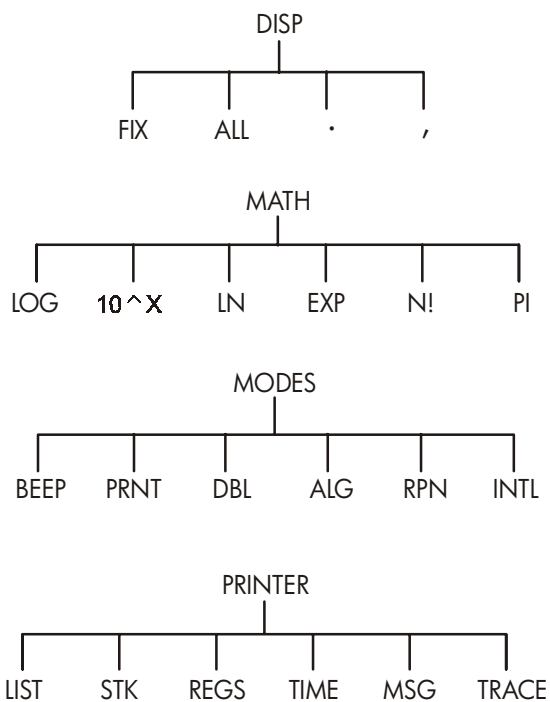


**Figure C-5. TIME Menu**

\* For the complete menu, see pages 30-31.



**Figure C-6. SOLVE Menu**



**Figure C-7. DSP, MATH, MODES, and PRINTER Menus**

\* For the complete menu, see pages 30-31.

**260 C: Menu Maps**

# D

## RPN: Summary

---

### About RPN

The RPN appendixes (D, E, and F) are especially for those of you who want to use or learn *RPN*—Hewlett-Packard’s original *Reverse Polish Notation* for operating calculators. This calculator can use *either* RPN or algebraic logic for calculations—you choose which.

HP’s RPN operating logic is based on an unambiguous, parentheses-free mathematical logic known as “Polish Notation,” developed by the Polish logician Jan Łukasiewicz (1878–1956). While conventional algebraic notation places the operators *between* the relevant numbers or variables, Łukasiewicz’s notation places them *before* the numbers or variables. For optimal efficiency of the stack, we have modified that notation to specify the operators *after* the numbers. Hence the term *Reverse Polish Notation*, or *RPN*.

Except for the RPN appendixes, the examples and keystrokes in this manual are written entirely using Algebraic (ALG) mode.

---

### About RPN on the HP 17bII+

This appendix replaces much of chapter 2, “Arithmetic.” It assumes that you already understand calculator operation as covered in chapter 1, “Getting Started.” Only those features unique to RPN mode are summarized here:

- RPN mode.
- RPN functions.
- RPN arithmetic, including percentages and  $\boxed{\text{STO}}$  and  $\boxed{\text{RCL}}$  arithmetic.

All other operations—including the Solver—work the same in RPN and ALG modes. (The Solver uses algebraic logic only.)

For more information about how RPN works, see appendix E, “RPN: The Stack.” For RPN keystrokes of selected examples from chapter 14, see appendix F, “RPN: Selected Examples.” Continue reading in chapter 2 to learn about the other functionality of your calculator.



Watch for this symbol in the margin earlier in the manual. It identifies keystrokes that are shown in ALG mode and must be performed differently in RPN mode. Appendixes D, E, and F explain how to use your calculator in RPN mode. The mode affects only arithmetic calculations—all other operations, including the Solver, work the same in RPN and ALG modes.

---

## Setting RPN Mode

The calculator operates in either RPN (*Reverse Polish Notation*) or ALG (*Algebraic*) mode. This mode determines the operating logic used for arithmetic calculations.

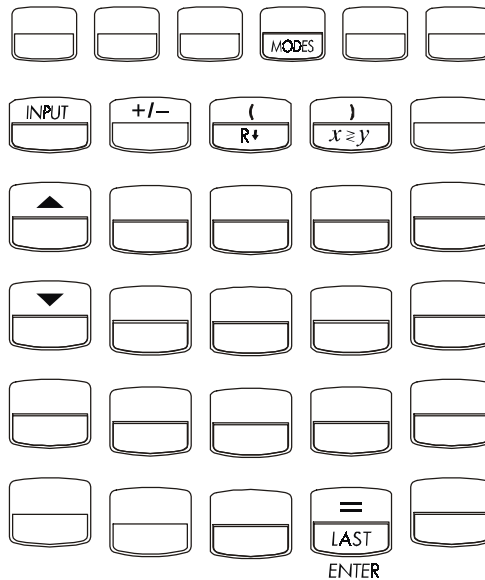
**To select RPN mode:** Press  **MODES**  **RPN**.

The calculator responds by displaying **RPN MODE**. This mode remains until you change it. The display shows the X register from the stack.

**To select ALG mode:** Press  **MODES**  **ALG**. The calculator displays **ALGEBRAIC MODE**.

## 262 D: RPN: Summary

## Where the RPN Functions Are



Function Name	Definition	Key to Use
ENTER	Enters and separates one number from the next.	
LASTX	Recalls last number in X-register.	
R ↓	Rolls down stack contents.	(same as )
R ↑	Rolls up stack contents.	(except in lists)
X < > Y	X-register exchanges with Y-register.	(same as )
CHS	Changes sign.	

### D: RPN: Summary 263

**Using INPUT for ENTER and ▼ for R ↓.** Except in CFLO and SUM lists, the **INPUT** key also performs the **ENTER** function and the **▼** key also performs the **R↓** function.

- In lists: **INPUT** stores numbers. Use **=** to enter numbers into the stack during arithmetic calculations.
- In lists: **▲** and **▼** move through lists. Use **R↓** to roll through stack contents.

---

## Doing Calculations in RPN

### Arithmetic Topics Affected by RPN Mode

This discussion of arithmetic using RPN replaces those parts of chapter 2 that are affected by RPN mode. These operations are affected by RPN mode:

- Two-number arithmetic (**+**, **×**, **-**, **÷**, **y<sup>x</sup>**).
- The percent function (**%**).
- The LAST X function (**LAST**). See appendix E.

RPN mode does *not* affect the MATH menu, recalling and storing numbers, arithmetic done inside registers, scientific notation, numeric precision, or the range of numbers available on the calculator, all of which are covered in chapter 2.



### Simple Arithmetic












Here are some examples of simple arithmetic. Notice that



- **ENTER** separates numbers that you key in.
- The operator (**+**, **-**, etc.) *completes* the calculation.
- One-number functions (such as **√x**) work the same in ALG and RPN modes.

## 264 D: RPN: Summary







To select RPN mode, press  **MODES**  **RPN**.








<b>To Calculate:</b>	<b>Press:</b>	<b>Display:</b>
12 + 3	12  3 	15.00
12 - 3	12  3 	9.00
12 x 3	12  3 	36.00
12 ÷ 3	12  3 	4.00
12 <sup>2</sup>	12 	144.00
$\sqrt{12}$	12 	3.46
1/12	12 	0.08

You do not need to use  before an operator, only *between keyed-in numbers*. Key in *both* numbers (separated by ) before pressing the operator key.

**The Power Function (Exponentiation).** The power function uses the  keys.

<b>To Calculate:</b>	<b>Press:</b>	<b>Display:</b>
12 <sup>3</sup>	12  3 	1,728.00
12 <sup>1/3</sup> (cube root)	12  3  	2.29

**The Percent Function.** The  key calculates percentages *without* using the  key. Combined with  or , it adds or subtracts percentages.

<b>To Calculate:</b>	<b>Press:</b>	<b>Display:</b>
27% of 200	200  27 	54.00
200 less 27%	200  27  	146.00
12% greater than 25	25  12  	28.00

Compare these keystrokes in RPN and ALG modes:

	<b>RPN Mode</b>	<b>ALG Mode</b>
27% of 200	200 <b>ENTER</b> 27 <b>%</b>	200 <b>×</b> 27 <b>%</b> <b>=</b>
200 less 27%	200 <b>ENTER</b> 27 <b>%</b> <b>=</b>	200 <b>=</b> 27 <b>%</b> <b>=</b>

## Calculations with STO and RCL

The store (**STO**) and recall (**RCL**) operations work identically in ALG and RPN modes (see “Storing and Recalling Numbers” and “Doing Arithmetic Inside Registers and Variables” in chapter 2). The keystrokes are the same for simple storing and recalling and for doing arithmetic *inside* registers and variables.

When doing arithmetic *in the display* with values from storage registers and variables, remember to use RPN. Compare these keystrokes in RPN and ALG modes:

	<b>RPN Mode</b>	<b>ALG Mode</b>
Store—2 x 3 in register 5	2 <b>+/-</b> <b>ENTER</b> 3 <b>×</b> <b>STO</b> 5	2 <b>+/-</b> <b>×</b> 3 <b>=</b> <b>STO</b> 5
Find PV—2	<b>FIN</b> <b>TVM</b> <b>RCL</b> PV 2 <b>=</b>	<b>FIN</b> <b>TVM</b> <b>RCL</b> PV <b>=</b> 2 <b>=</b>
Find PV less 2%	<b>FIN</b> <b>TVM</b> <b>RCL</b> PV 2 <b>%</b> <b>=</b>	<b>FIN</b> <b>TVM</b> <b>RCL</b> PV <b>=</b> 2 <b>%</b> <b>=</b>
Find PMT x N	<b>FIN</b> <b>TVM</b> <b>RCL</b> PMT <b>RCL</b> N <b>×</b>	<b>FIN</b> <b>TVM</b> <b>RCL</b> PMT <b>×</b> <b>RCL</b> N <b>=</b>

## Chain Calculations—No Parentheses!

The speed and simplicity of calculating using RPN are apparent during *chain calculations*—longer calculations with more than one operation. The RPN memory stack (refer to appendix E) stores intermediate results until you need them, then inserts them into the calculation.

## 266 D: RPN: Summary

The cube root example and the percentage addition example (previous topics) are two simple examples of chain calculations.

For another example, calculate

$$7 \times (12 + 3)$$

Start the calculation inside the parentheses by finding  $12 + 3$ . Notice that you don't need to press **ENTER** to save this intermediate result (15) before proceeding. Since it is a calculated result, it is saved automatically—*without using parentheses*.

<b>Keys:</b>	<b>Display:</b>	<b>Description:</b>
12 <b>ENTER</b> 3 <b>+</b>	15.00	Intermediate result.
7 <b>×</b>	105.00	Pressing the function key produces the answer.

Now study these examples. Note the automatic storage *and retrieval* of intermediate results.

<b>To Calculate:</b>	<b>Press:</b>	<b>Display:</b>
$(750 \times 12) \div 360$	750 <b>ENTER</b> 12 <b>×</b> 360 <b>÷</b>	25.00
$360 \div (750 \times 12)$	360 <b>ENTER</b> 750 <b>ENTER</b> 12 <b>×</b> <b>÷</b>	0.04
	or	
	750 <b>ENTER</b> 12 <b>×</b> 360 <b>xy</b> <b>÷</b>	
$\{(456 - 75) \div 18.5\}$	456 <b>ENTER</b> 75 <b>-</b> 18.5 <b>÷</b> 68	
$\times (68 \div 1.9)$	<b>ENTER</b> 1.9 <b>÷</b> <b>×</b>	737.07
$(3 + 4) \times (5 + 6)$	3 <b>ENTER</b> 4 <b>+</b> 5 <b>ENTER</b> 6 <b>+</b> <b>×</b>	77.00

# E

## RPN: The Stack

---

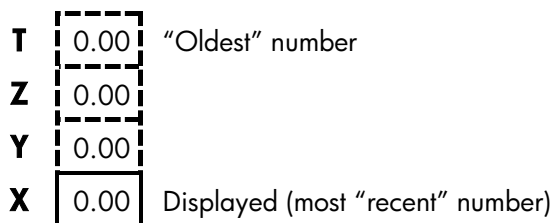
This appendix explains how calculations take place in the automatic memory stack and how this method minimizes keystrokes in complicated calculations.

---

### What the Stack Is

*Automatic storage of intermediate results* is the reason that RPN mode easily processes complicated calculations—without using parentheses. The key to automatic storage is the *automatic RPN memory stack*.

The memory stack consists of up to four storage locations, called *registers*, which are “stacked” on top of each other. It is a work area for calculations. These registers—labeled X, Y, Z, and T—store and manipulate four current numbers. The “oldest” number is the one in the T-(*top*) register.



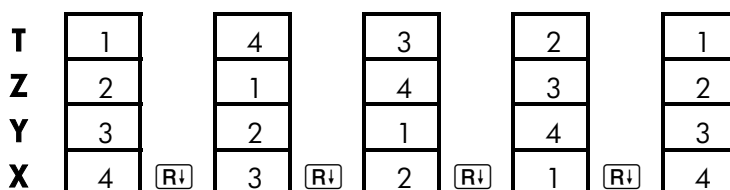
The most “recent” number is in the X-register: *This is the number you see in the display.*

## Reviewing the Stack (Roll Down)

The  $\boxed{R\downarrow}$  (roll down) function (on the  $\boxed{\downarrow}$  key) lets you review the entire contents of the stack by “rolling” the contents downward, one register at a time. While in RPN mode you don’t need to press the shift key for  $\boxed{R\downarrow}$ .

The  $\boxed{\downarrow}$  key has the same effect as  $\boxed{R\downarrow}$ , except in a CFLO or SUM list, when  $\boxed{\downarrow}$  affects the list and *not* the stack. Likewise, the  $\boxed{\uparrow}$  key rolls the contents of the stack upward, except in lists.

**Rolling a Full Stack.** Suppose the stack is filled with 1, 2, 3, 4 (press 1  $\boxed{\text{ENTER}}$  2  $\boxed{\text{ENTER}}$  3  $\boxed{\text{ENTER}}$  4). Pressing  $\boxed{R\downarrow}$  four times rolls the numbers all the way around and back to where they started:



When you press  $\boxed{R\downarrow}$ , the value in the X-register rotates around into the T-register. Notice that the *contents* of the registers are rolled, while the registers themselves maintain their positions. The calculator displays only the X-register.

**Variable Stack Size.** Clearing the stack by pressing  $\boxed{\text{CLR DATA}}$  reduces the stack to one register (X) with a zero in it. As you enter numbers, the stack builds up again. The  $\boxed{R\downarrow}$  and  $\boxed{\uparrow}$  functions roll through as many registers as currently exist (one, two, three, or four).

## Exchanging the X- and Y-Registers in the Stack

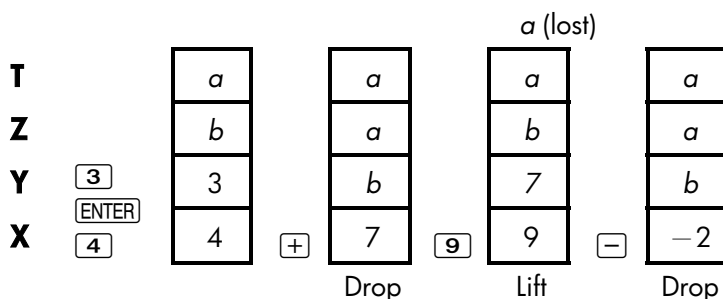
Another function that manipulates the stack contents is  $\boxed{x\leftrightarrow y}$  (x exchange y), located on the  $\boxed{\leftrightarrow}$  key. It swaps the contents of the X- and Y-registers without affecting the rest of the stack. Pressing  $\boxed{x\leftrightarrow y}$  again restores the original order of the contents. While in RPN mode you don’t need to press the shift key for  $\boxed{x\leftrightarrow y}$ .

The  $\boxed{x \leftrightarrow y}$  function is used primarily to swap the order of numbers in a calculation. For example, an easy way to calculate  $9 \div (13 \times 8)$  is to press 13  $\boxed{\text{ENTER}}$  8  $\boxed{\times}$  9  $\boxed{x \leftrightarrow y}$   $\boxed{\div}$ .

## Arithmetic—How the Stack Does It

The contents of the stack move up and down automatically as new numbers enter the X-register (*lifting the stack*), and as operators combine two numbers to produce one new number in the X-register (*dropping the stack*). See how a full stack drops, lifts, and drops its contents while calculating

$$3 + 4 - 9 :$$



(*a* and *b* represent values already on the stack.)

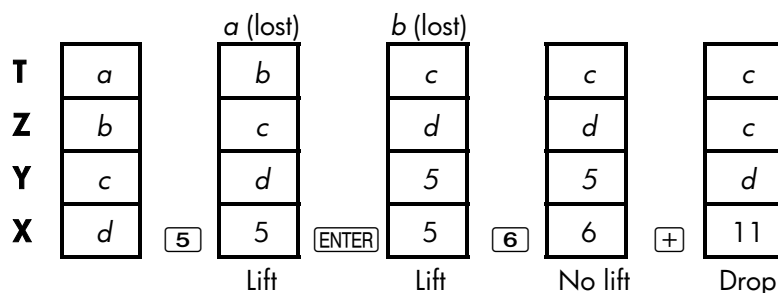
- Notice that when the stack drops, it replicates the contents of the T-register and overwrites the X-register.
- When the stack lifts, it pushes the top contents out of the T-register, and that number is lost. This shows that the stack's memory is limited to four numbers for calculations.
- Because of the automatic movement of the stack, you do *not* need to clear the display before doing a new calculation.
- Most functions (except  $\boxed{\text{ENTER}}$  and  $\boxed{\text{CLR}}$ ) prepare the stack to lift its contents *when the next number enters the X-register*.

## 270 E: RPN: The Stack

## How ENTER Works

You know that **ENTER** separates two numbers keyed in one after the other. In terms of the stack, how does it do this? Suppose the stack is filled with  $a$ ,  $b$ ,  $c$ , and  $d$ . Now enter and add two new numbers:

$$5 + 6 :$$



**ENTER** replicates the contents of the X-register into the Y-register. The next number you key in (or recall) *writes over* (instead of lifting) the copy of the first number left in the X-register. The effect is simply to separate two sequentially entered numbers.

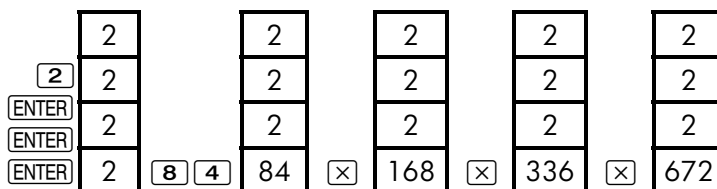
**Using a Number Twice in a Row.** You can use the replicating feature of **ENTER** to other advantages. To add a number to itself, key in the number and press **ENTER** **+**.

**Filling the Stack with a Constant.** The replicating effect of **ENTER**, together with the replicating effect (from T into Z) of stack drop, allows you to fill the stack with a numeric constant for calculations.

**Example: Constant, Cumulative Growth.** The annual sales of a small hardware company are projected to double each year for the next 3 years. If the current sales are \$84,000, what are the annual sales for each of the next 3 years?

1. Fill the stack with the growth rate (2 **ENTER** **ENTER** **ENTER**).
2. Key in the current sales in thousands (84).

3. Calculate future sales by pressing  $\times$  for each of the next 3 years.



Sales for the next 3 years are projected to be \$168,000; \$336,000; and \$672,000.

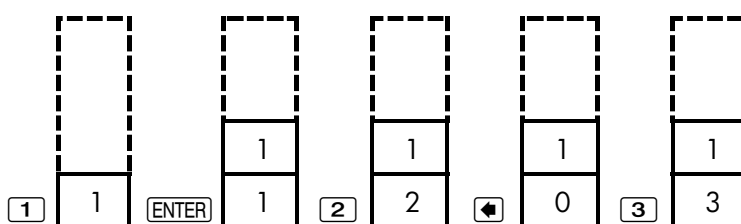
## Clearing Numbers

**Clearing One Number.** Clearing the X-register puts a zero in it. The next number you key in (or recall) *writes over* this zero.

There are two ways to clear the number in the X-register:

- Press  $\leftarrow$ .
- Press  $\text{CLR}$ .

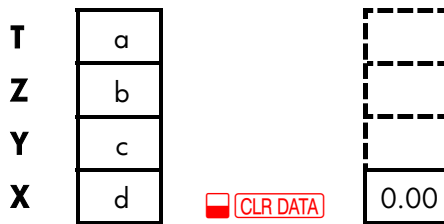
For example, if you wanted to enter 1 and 3 but mistakenly entered 1 and 2, these keystrokes would correct it:




**Clearing the Entire Stack.** Pressing  $\text{CLR DATA}$  clears the X-register to zero and eliminates the Y-, Z-, and T-registers (reducing the size of the stack to one register). The stack expands again when you enter more numbers.

## 272 E: RPN: The Stack






Because of the automatic movement of the stack, it is *not* necessary to clear the stack before starting a calculation. Note that if an application menu is currently displayed, pressing  also clears the application's variables.

---



## The LAST X Register

### Retrieving Numbers from LAST X

The LAST X register is a companion to the stack: It stores the number that had been in the X-register *just before the last numeric operation* (such as a  $\otimes$  operation). Pressing  returns this value to the X-register. This ability to recall the "last x" value has two main uses:

- Correcting errors: retrieving a number that was in the X-register just before an incorrect calculation.
- Reusing a number in a calculation.

### Reusing Numbers

You can use  to reuse a number (such as a constant) in a calculation. Remember to enter the constant second, just before executing the arithmetic operation, so that the constant is the last number in the X-register, and therefore can be saved and retrieved with .

Example: Calculate  $\frac{96.74 + 52.39}{52.39}$

Keys:	Display:	Description:
96.74 <b>ENTER</b>	96.74	
52.39 <b>+</b>	149.13	Intermediate result.
<b>LAST</b>	52.39	Retrieves the number before the <b>+</b> operation, saved in LAST X.
<b>÷</b>	2.85	Final result.

---

## Chain Calculations

The automatic lifting and dropping of the stack's contents let you retain intermediate results without storing or reentering them, and without using parentheses. This is an advantage the RPN stack has over algebraic calculator logic. Other features of RPN include the following:

- You never work with more than two numbers at a time.
- **ENTER** separates two numbers keyed in sequentially.
- Pressing an operator key executes that operation immediately.
- Intermediate results appear as they are calculated, so you can check each step as you go.
- Intermediate results are automatically stored. They reappear automatically as they are needed for the calculation—the last result stored is the first to come back out.
- You can calculate in the same order as you would with pencil and paper—that is, from the innermost parentheses outward:

$$4 \div [14 + (7 \times 3) - 2] = 0.12$$

can be solved as 7 **ENTER** 3 **×** 14 **+** 2 **-** 4 **x↔y** **÷**

## 274 E: RPN: The Stack

## Exercises

Here are some extra problems that you can do to practice using RPN.

**Calculate:**  $(14 + 12) \times (18 - 12) \div (9 - 7) = 78.00$

**A Solution:** 14 [ENTER] 12 [+] 18 [ENTER] 12 [-] [×] 9 [ENTER] 7 [-] [÷]

**Calculate:**  $23^2 - (13 \times 9) + \frac{1}{7} = 412.14$

**A Solution:** 23 [x<sup>2</sup>] 13 [ENTER] 9 [×] [-] 7 [1/x] [+]

**Calculate:**  $\sqrt{(5.4 \times 0.8) \div (12.5 - 0.7^3)} = 0.60$

**A Solution:** 5.4 [ENTER] .8 [×] .7 [ENTER] 3 [y<sup>x</sup>] 12.5 [x<sup>y</sup>] [-] [÷] [√x]

or

5.4 [ENTER] .8 [×] 12.5 [ENTER] .7 [ENTER] 3 [y<sup>x</sup>] [-] [÷] [√x]

**Calculate:**  $\sqrt{\frac{8.33 \times (4 - 5.2) \div [(8.33 - 7.46) \times 0.32]}{4.3 \times (3.15 - 2.75) - (1.71 \times 2.01)}} = 4.57$

**A Solution:** 4 [ENTER] 5.2 [-] 8.33 [×] [LAST] 7.46 [-] .32 [×] [÷]  
3.15 [ENTER] 2.75 [-] 4.3 [×] 1.71 [ENTER] 2.01 [×] [-] [÷] [√x]

# F

## RPN: Selected Examples

---

The following examples selected from chapter 14 (“Additional Examples”) have been converted to RPN keystrokes. These examples illustrate how to convert algebraic to RPN keystrokes in less common situations: with  $\boxed{\%}$ , with  $\boxed{\text{RCL}}$ , and in a CFLO list.

**Example: Simple Interest at an Annual Rate.** Your good friend needs a loan to start her latest enterprise and has requested that you lend her \$450 for 60 days. You lend her the money at 7% simple annual interest, to be calculated on a 365-day basis. How much interest will she owe you in 60 days, and what is the total amount owed?

Keys:	Display:	Description:
450 $\boxed{\text{ENTER}}$ 7 $\boxed{\%}$	31.50	Annual interest.
60 $\boxed{\times}$ 365 $\boxed{\div}$	5.18	Actual interest for 60 days.
450 $\boxed{+}$	455.18	Adds principal to get total debt.

**Example: APR for a Loan with Fees.** A borrower is charged two points for the issuance of a mortgage. (One point is equal to 1% of the mortgage amount.) If the mortgage amount is \$60,000 for 30 years and the interest rate is 11½% annually with monthly payments, what APR is the borrower paying?

1. Since the payment amount is not given, calculate it (*PMT*) first. Use the given mortgage amount (*PV* = \$60,000) and interest rate (*I%YR* = 11½%).
2. To find the APR (the new *I%YR*), use the *PMT* calculated in step 1 and

### 276 F: RPN: Selected Examples

adjust the mortgage amount to reflect the points paid ( $PV = \$60,000 - 2\%$ ). All other values remain the same (term is 30 years; no future value).

**Keys:**

**Display:**

**Description:**

FIN TMM

OTHER

CLR DATA

EXIT

30  N

11.5 I%YR

60000 PV

0 FV

PMT

RCL PV

2  (%)  PV

I%YR

12 P/YR END  
MODE

N=360.00

PV=60,000.00

FV=0.00

PMT=-594.17

PV=58,800.00

I%YR=11.76

If necessary, sets 12 payments per year and End mode.

Figures and stores number of payments.

Stores interest rate and amount of loan.

No balloon payment, so future value is zero.

Borrower's monthly payment.

Stores actual amount of money received by borrower into PV.

Calculates APR.

**Example: Loan from the Lender's Point of View.** A \$1,000,000 10-year, 12% (annual interest) *interest-only* loan has an origination fee of 3 points. What is the yield to the lender? Assume that monthly payments of interest are made. (Before figuring the yield, you must calculate the monthly  $PMT = (loan \times 12\%) \div 12 \text{ mos.}$ ) When calculating the I%YR, the FV (a balloon payment) is the entire loan amount, or \$1,000,000, while the PV is the loan amount minus the points.

**Keys:**

FIN TVM

OTHER

CLR DATA

EXIT

10 N

1000000 ENTER

12 %

12 ÷ PMT

1000000 FV

3 % - +/-

PV

I%YR

**Display:**

12 P/YR END

MODE

N=120.00

120,000.00

PMT=10,000.00

FV=1,000,000.00

PV=-970,000.00

I%YR=12.53

**Description:**

If necessary, sets 12 payments per year and End mode.

Stores total number of payments.

Calculates annual interest on \$1,000,000.

Calculates, then stores, monthly payment.

Stores entire loan amount as balloon payment.

Calculates, then stores, amount borrowed (total - points).

Calculates APR—the yield to lender.

**Example: Savings for College.** Your daughter will be going to college in 12 years and you are starting a fund for her education. She will need \$15,000 at the beginning of each year for four years. The fund earns 9% annually, compounded monthly. You plan to make monthly deposits, starting at the end of the current month. How much should you deposit each month to meet her educational expenses?

See figures 14-1 and 14-2 (chapter 14) for the cash-flow diagrams.

Remember to press the  $\equiv$  key for ENTER while working in a list. (Pressing INPUT will add data to the list, not perform an ENTER.)

**278 F: RPN: Selected Examples**

**Keys:**

FIN CFLO

 CLR DATA

YES

or

GET #NEW FLOW(0)=?

**Display:****Description:**

Displays current cash-flow list and CFLO menu keys.

Clears current list or gets a new one.

**Step 1:** Set up a CFLO list.**Keys:**

0 INPUT

0 INPUT

12 ENTER 12  $\times$  1  $\ominus$   
INPUT

15000 INPUT

INPUT

0 INPUT

11 INPUT

15000 INPUT INPUT FLOW(5)=?

**Display:**

FLOW(1)=?

#TIMES(1)=1

FLOW(2)=?

#TIMES(2)=1

FLOW(3)=?

#TIMES(3)=1

FLOW(4)=?

FLOW(5)=?

**Description:**

Sets initial cash flow,  $FLOW(0)$ , to zero.

Stores zero in  $FLOW(1)$  and prompts for the number of times it occurs. For ENTER, press  $\ominus$ , not INPUT. Stores 143 (for 11 years, 11 months) in #TIMES(1) for  $FLOW(1)$ .

Stores amount of first withdrawal, at end of 12th year.

Stores cash flows of zero ...  
... for the next 11 months.

Stores second withdrawal, for sophomore year.

**F: RPN: Selected Examples 279**

0	<input type="text" value="INPUT"/>	11	<input type="text" value="INPUT"/>	FLOW(6)=?	Stores cash flows of zero for the next 11 months.
15000	<input type="text" value="INPUT"/>	<input type="text" value="INPUT"/>		FLOW(7)=?	Stores third withdrawal, for junior year.
0	<input type="text" value="INPUT"/>	11	<input type="text" value="INPUT"/>	FLOW(8)=?	Stores cash flows of zero for the next 11 months.
15000	<input type="text" value="INPUT"/>	<input type="text" value="INPUT"/>		FLOW(9)=?	Stores fourth withdrawal, for senior year.
<input type="text" value="EXIT"/>	<input type="text" value="CALC"/>			NPV, NUS, NFV NEED I%	Done entering cash flows; gets CALC menu.

**Step 2:** Calculate *NUS* for the monthly deposit. Then calculate net present value.

<b>Keys:</b>	<b>Display:</b>	<b>Description:</b>
9 <input type="text" value="ENTER"/> 12 <input type="text" value="÷"/>		
<input type="text" value="I%"/>	I%=8.75	Figures the periodic (monthly) interest rate and stores it in <i>I%</i> .
<input type="text" value="NUS"/>	NUS=182.30	Amount of monthly deposit needed to meet planned withdrawals.
<input type="text" value="NPV"/>	NPV=17,973.48	Calculates the net present value of the monthly deposits, which is the same as the NPV of the four future withdrawals.

**Example: Tax-Free Account.** Consider opening an IRA account with a dividend rate of 8.175%. 1) If you invest \$2,000 at the beginning of each year for 35 years, how much will you have at retirement? 2) How much will you have paid into the IRA? 3) How much interest will you have earned? 4) If your post-retirement tax rate is 15%, what is the

## 280 F: RPN: Selected Examples



after-tax future value of the account? Assume only the interest will be taxed (the principal was taxed before deposit). 5) What is the purchasing power of that amount, in today's dollars, assuming an 8% annual inflation rate?

<b>Keys:</b>	<b>Display:</b>	<b>Description:</b>
FIN TVM		
OTHER 1 P/YR		Sets 1 payment per year and Begin mode.
BEG (EXIT)	1 P/YR BEGIN MODE	
35 N	N=35.00	Stores number of payment periods until retirement (1 x 35).
8.175 I%YR	I%YR=8.18	Stores dividend rate.
0 PV	PV=0.00	Present value of account (before first payment).
2000 +/- PMT	PMT=-2,000.00	Annual payment (deposit).
FV	FV=387,640.45	Calculates amount in account at retirement.
(RCL) PMT (RCL)		Calculates total amount paid into IRA by retirement.
N (X)	-70,000.00	
(RCL) FV (+)	317,640.45	Calculates interest you will earn.
15 (%)	47,646.07	Taxes at 15% of interest.
+/- (RCL) FV		Subtracts taxes from total FV to calculate after-tax FV.
(+)	339,994.39	
FV	FV=339,994.39	Stores after-tax future value in FV.

## F: RPN: Selected Examples 281

8 I%YR 0 PMT  
 PV PV=-22,995.36

Calculates present-value purchasing power of the above after-tax *FV* at 8% inflation rate.

**Example: Taxable Retirement Account.** If you invest \$3,000 each year for 35 years, with dividends taxed as ordinary income, how much will you have in the account at retirement? Assume an annual dividend rate of 8.175% and a tax rate of 28%, and that payments begin today. What will be the purchasing power of that amount in today's dollars, assuming 8% annual inflation?

**Keys:**

FIN TVM  
 OTHER 1 P/YR  
 BEG (EXIT)

35 N

8.175 (ENTER) 28 (%)

(=)

I%YR

0 PV

3000 (+/-) PMT

FV

8 I%YR 0 PMT

PV

**Display:**

1 P/YR BEGIN  
 MODE

N=35.00

5.89

I%YR=5.89

PV=0.00

PMT=-3,000.00

FV=345,505.61

PV=-23,368.11

**Description:**

Displays TVM menu.

Sets 1 payment per year and Begin mode.

Stores years until retirement.

Calculates interest rate diminished by tax rate.

Stores interest rate.

Stores no present value.

Stores annual payment.

Calculates future value.

Calculates present-value purchasing power of the above *FV* at 8% inflation.

**282 F: RPN: Selected Examples**

## Error Messages

---

The calculator beeps and displays an error message under certain circumstances—for example, when you attempt an operation that is not allowed.

The calculator distinguishes between math errors that occur on the calculator line and other types of messages by preceding math-error messages with the word **ERROR** :

Press **CLR** or **↵** to erase the message and restore the previous display.

### **BAD GUESSES :**

**PRESS [CLR] TO VIEW**

The Solver cannot begin a numerical search using the initial estimates. See pages 180 and 239.

### **BATT TOO LOW TO PRINT**

To conserve battery power, the calculator will not transmit data to the printer until fresh batteries have been installed.

### **CURRENT LIST UNNAMED :**

**NAME OR CLEAR THE LIST**

Attempted to get another list without first clearing or naming the current list. Press **CLR DATA** to clear it or **NAME** to name it.

### **EMPTY LIST**

Attempted a calculation using an empty CFLO or SUM list.

**ERROR : LOGARITHM(NEG)**

**ERROR : LOGARITHM(0)**

Attempted to take the base 10 or natural log of a negative number or zero. This can happen during curve-fitting calculations if you attempt to calculate:

- A logarithmic forecasting model with a negative or zero x-value.
- An exponential model with a negative or zero y-value.
- A power model with a negative or zero x- or y-value.

**ERROR: NEG^NONINTEGER**

Attempted to raise a negative number to a non-integer power.

**ERROR: OVERFLOW**

An internal result in a calculation was too large for the calculator to handle.

**ERROR: SQRT(NEG)**

Attempted to take the square root of a negative number or calculate *G.SD* given any negative frequencies.

**ERROR: UNDERFLOW**

An internal result in a calculation was too small for the calculator to handle.

**ERROR: 0^NEG**

Attempted to raise zero to a negative power.

**ERROR: 0÷0**

Attempted to divide zero by zero.

**ERROR: 0^0**

Attempted to raise zero to the zero power.

**ERROR: ÷0**

Attempted to divide by zero.

**INPUTS CAUSED ÷0**

## **284 Error Messages**

The numbers stored into built-in variables caused a division by zero in the calculation. You must change one or more stored values. (Refer to the equations in appendix B to see which variables appear in the divisor.)

#### INSUFFICIENT DATA

- Attempted to calculate standard deviation with only one value in the list.
- Attempted to do curve fitting using an  $x$ -variable list in which all the values are equal.
- Attempted to do curve fitting using the logarithmic or power models with a list for which the transformed values of  $x$  ( $\ln x$ ) are equal.

#### INSUFFICIENT MEMORY

The calculator has insufficient memory available to do the operation you've specified. Refer to "Managing Calculator Memory" on page 227 for additional information.

#### INTEREST $\leq -100\%$

One of the following values for interest is less than or equal to  $-100$ :

- TVM menu:  $I\%YR \div P/YR$ .
- PER menu:  $NOM\% \div P$  (calculating  $EFF\%$ );  $EFF\%$  (calculating  $NOM\%$ ).
- CONT menu:  $EFF\%$ .
- CFLO menu:  $I\%$  (calculating  $NPV$ ,  $NUS$ , or  $NFV$ ) or estimate of  $IRR\%$ .

#### INTERRUPTED

Calculation of  $I\%YR$ ,  $IRR\%$ , amortization results, a Solver variable, or a SUM-list sort was interrupted.

#### INVALID DATE

- The number entered cannot be interpreted as a proper date. Check its format (page 143).
- Attempted to set a date outside the range 1/1/2000 through 12/31/2099, or attempted date arithmetic outside the range 10/15/1582 through 12/31/9999.

#### INVALID EQUATION

- The Solver cannot interpret the equation due to a syntax error. Refer to "What Can Appear in an Equation," page 166.
- A variable's name is invalid. Refer to "Names of Variables," page 166.

#### INVALID INPUT

- Attempted to store into a built-in variable a number that is outside the range of values permitted for that variable.
- The number entered cannot be interpreted as a proper time.
- The appointment's repeat interval is out of range.
- Attempted to enter a non-integer, negative number when specifying the number of displayed decimal places (in DSP).

#### INVALID N

Attempted to calculate  $I\%YR$  with  $N \leq 0.99999$  or  $N \geq 10^{10}$ .

```
IRR% > 0 EXISTS; KEY
IN GUESS; [CSTO] {IRR%}
```

Calculation of  $IRR\%$  produced a negative answer, but the calculator has determined that there is also a unique positive answer. (Refer to page 238.)

#### MACHINE RESET

The calculator has been reset (page 224, 228).

## 286 Error Messages

#### MANY OR NO SOLUTIONS

The calculator is unable to calculate  $I\%YR$ . Check the values stored in  $PV$ ,  $PMT$ , and  $FV$ . Make sure the signs of the numbers are correct. If the values of  $PV$ ,  $PMT$ , and  $FV$  are correct, the calculation is too complex for the  $TVM$  menu. You may be able to perform the calculation using the  $CFLO$  menu to calculate  $IRR\%$ .

#### MANY/NO SOLUTIONS: KEY

IN GUESS: [STO] (IRR%)

The calculation of  $IRR\%$  is complex, and requires you to store a guess. (Refer to page 238.)

#### MEMORY LOST

Continuous Memory has been erased (page 224, 230).

#### NAME ALREADY USED:

TYPE A NAME: [INPUT]

The list name you've attempted to enter is already in use; type in a new name and press [INPUT].

#### NO SOLUTION

No solution is possible using the values stored in the current built-in menu or list. This most commonly results from an incorrect sign for a cash flow or other monetary value. (Review page 64.)

#### N! N<0 OR N NONINTEGER

Attempted to calculate the factorial of a negative or non-integer value.

#### OVERFLOW

A warning—*not an error*—that the magnitude of a result is too large for the calculator to handle, so it returns  $\pm 9.999999999999999E499$  rounded to the current display format. See page 47 for limits.

#### SOLUTION NOT FOUND

No solution was found for a Solver equation using the current values stored in its variables. Refer to page 246 in appendix B.

#### **UNDERFLOW**

A warning—*not an error*—that the magnitude of a result is too small for the calculator to handle, so it returns the value zero. See page 47 for limits.

#### **UNEQUAL LIST LENGTHS**

Attempted a two-list SUM calculation using lists of unequal lengths.


## **288 Error Messages**




# Index

## Special Characters

, **47**

 low-battery annunciator,  
17, 184, **224**

 shift annunciator, **19**

, **40**

%TOTL menu  
formula, **247**  
using, **51**

, **22**

$\Sigma$ , 139, 171, **176–77**, 220

, **35**

, **35**

#P, **78**

#T?, **92, 95**, 96–97

\*NEW, 127

%CHG, **49, 50**

%TOTL, **49, 51**

%T, **51**

$\Sigma X$ , **132**, 139

$\Sigma Y$ , **132**, 139

$\Sigma X^2$ , **132**, 139

$\Sigma Y^2$ , **132**, 139

$\Sigma XY$ , **132**, 139

+HR, 144


-MIN, 144

12/24, **143**

10^X, **42**

360D, **150**

365D, **150**

(()) alarm annunciator, **147**

%CHG menu

formula, **247**

using, **50**

< or >, 174

→, →→, ←←,

←←←, **32**


, 19


 or , **43**, 269

editing a list, 98

in a list, 96, **162**


with history stack, **43**

, **20**, 32, 272

, 174

1/x, **41**

✓, 16, 17, 262

 print annunciator, 184

#TIMES, **96–97**

## A

A\$, R, **56**

ACRS%, **115**

ACRS, **115**

**ALG** , 36, **262**  
**ACCRU** , **109**  
**ALL** key, **34**  
**APT1** through **APT10** , **145**  
**A/PM** , appointment-setting menu, **145**  
 ABS (absolute value) function, **169**  
 Accrued interest, on bond, **109**, 111  
 Accuracy of the clock, **231**  
 Acknowledging appointments, **147**  
 Actual calendar  
     actuarial equations, **246**  
     for arithmetic, **149**  
     for bonds, **110**  
 Addition, **21**  
 ADJUST menu, **144**  
 Advance payments, **74–77**, 199–200, 253. *See also*  
     Leasing  
 Algebraic  
     mode, 36, **262**  
     rules in equations, **164–66**  
 ALOG, **169**  
 Alphabetic keys, **30–32**  
 ALPHAbetic menu, **30**  
 AM/PM format, **143**  
 Amortization  
     calculations, **77–81**  
     equations, **247**  
     schedule, **78**  
         schedule, printing, **81–83**  
 AMRT menu, **78**  
 AND operator, 166, **174**  
 Annual percentage interest rate  
     in TVM, **63**  
     with fees, **193**  
     with fees, RPN, 276  
 Annunciators, **18**  
     definition, **18**  
     printer, **184**  
 Antilogarithms, **42**, 169  
 Appointment  
     menus, **142**, 145  
     messages, **146**  
     repeat interval, **147**, 148  
     -setting menu, **146**  
 Appointments  
     acknowledging, **147**  
     clearing, **148**  
     messages, **145**  
     past due, **146**  
     printing, **188**  
     setting, **146–47**  
     unacknowledged, 146, **148**  
 APPT menu, 145  
 APR for, with fees, RPN, 276  
     calculations, **67–71**  
     interest-only, **194**  
     interest-only, RPN, 276  
     odd-period, **195**, 196–97  
 Arithmetic, 21–22, **38**  
     in registers and variables, **46**  
     in RPN, 264–67, 270  
     in RPN stack, 270

## 290 Index

RPN examples, 275  
 Arithmetic priority, **154**  
 Arrow keys  
   for changing current equation, **156**  
   for editing, **32**  
   for finding an equation, **162**  
   for rolling the history stack, **43**  
   for viewing long equations, **166**

## B

**B**, **56**

**B**, **132**

**BAL**, **78**

**BEG**, **64**

**BASIS**, **115**

**BAHT**, **56**

Backspace key, **20**

Balance of loan, **80–81**

Balloon payment, **69–71**

Batteries, changing, **225–26**

Battery life, **224**  
   annunciator, **224**

Beeper, **147**

Beeper on and off, **36**

Begin payment mode, **64**, 66

Beginning of list  
   in CFLO list, **98**  
   in SUM list, **124**

Bond calculations, 110–13

equations, **249**  
 fractional values for, **111**  
 price, **111**  
 type, 109, **110**  
 yield, **111**

BOND menu, **108–9**

Bonds, **215–16**

Bottom  
   of the current list, in CFLO, **95**  
   of the Solver list, **162**

Braces in equations, **167**

Brackets in equations, **167**

Brightness of the display, **17**

Built-in variables. See Variables,  
   built-in

BUS menu, 49, **254**

Business variables, clearing, **50**

Buy option, for a lease, **75–77**

B-value, in curve fitting, **132**

## C

%CHG menu, **50**

**CALC**


  in CFLO menu, **92**  
   in SOLVE menu, **157**  
   in SUM menu, **122**  
   in TIME menu, **142**

**CPN%**, **109**

**CALL**, **109**

**CORR**, **132**

**C.STO**, **55**

**C.RCL**, **55**  
**CURR1**, **56**  
**CURR2**, **56**  
**COST** key, **53**  
**CAN\$**, **CZ\$**, **56**  
, **20, 28–29**  
**CLR**, 17, **20**, 32  
 ✓, 16, 17, 262  
**CALC** menu  
     in CFLO menu, **101**  
     in SOLVE menu, **158–59**  
     in SUM menu, **128**  
     in TIME menu, **150**  
 Calculations, RPN  
     order of, 274  
     parenthesis in, 266, 274  
 Calculator  
     not functioning, **231–32**  
     resetting, 225, **228–30**  
     Support, **222**  
 Calculator line  
     arithmetic in, **38–48**  
     definition, **18**  
     displaying alphabetic  
         information, **31–32**  
     editing, **20**  
 Calendar. *See also* Date  
     360-day, **150**  
     365-day, **150**  
     actual, **150**  
     range of, **149**  
 Calendar basis, **108–9**  
 Call, **110**, 112  
 Canadian mortgage, **197–99**,

252  
 Capitalized value, lease,  
     **74–75**  
 Cash flow  
     calculations, **91–107**  
     equations, **248**  
     list. *See* CFLO list  
 Cash flow diagrams  
     in cash flow calculations,  
         **92–94**  
     in TVM calculations, **64–66**  
 Cash flows  
     equal. *See* Cash flows,  
         grouped  
     grouped, **94**, 104  
     initial, 94, **95**  
     maximum number of, **91**  
     sum of, **101**  
     ungrouped, **93**  
     zero, 94, **95**  
**CDATE**, **169**  
**CFLO** list  
     **CALC** menu, **101**  
     clearing, **99**  
     copying from, **98**  
     correcting, **97**  
     creating, **94**  
     definition, **91**  
     deleting numbers, **98**  
     editing, 92, **97**  
     entering numbers in, **95–97**  
     GETting a new list, **99**  
     inserting numbers, **98**  
     name, clearing, **99**  
     naming, **98–99**  
     printing, **187**

## 292 Index

- signs of numbers, **92**
- starting a new list, **99**
- viewing name of current list, **99**
- viewing numbers, **97**
- Chain calculations, 21, **38–39**, 38
  - in RPN, 266, 274
- Changing
  - batteries, **225–26**
  - the sign of a number, **22**
- Characters
  - for CFLO list, **98–99**
  - for equation names, **161**
  - for SUM list, **126**
  - in equations, **166–67**
  - inserting and deleting, **31–32**
- Chi-squared, **219–20**
- Clearing, **20**
  - %CHG variables, **50**
  - %T variables, **50**
  - AMRT variables, **80**
  - appointments, 146, 148
  - BOND variables, **109**
  - BUS variables, **50**
  - calculator memory, **28–29**
  - CFLO lists, 95, **99**
  - ICNV variables, **86**
  - menu variables, **28**
  - menus, **28**
  - MU%C variables, **50**
  - MU%P variables, **50**
  - numbers in RPN, 272
  - Solver variables, **163**
  - SUM lists, **123**
  - the history stack, **44**
  - the RPN stack, 269, 272
  - TIME CALC variables, **150**
  - TVM variables, **64**
  - variables, **28–29**
- Clock. See Time
- Commas, in numbers, **35**
- Compound interest calculations, **61**
- Compounding
  - annual, **71**
  - monthly, **67**, 68, 74, 75
  - periods, 61, 62, 63, **64**
  - periods, vs. payment periods, **87–90**, 200
  - rates, **84**
  - semimonthly, **72**
- Conditional expressions, **174–76**
- Constant numbers, RPN, 271, 272
- Constants in equations, **166**
- CONT menu, **86**
- Continuous compounding, calculating interest for, **85**
- Continuous Memory, **37**
  - erasing, **225**, 230
  - using, **17**
- Contrast of display, changing, **17**
- Conventional investments, definition, **101**
- Converting interest rates, **85–87**

Correlation coefficient, **132**

Cost

markup on, 49, **52**

of capital, **101**

Counter variable, in summation  
function, **176**

Coupon

basis, **108–9**

payments, **108**

Creating

a CFLO list, **94–96**, 99

a new equation, in the Solver,  
**157–58**

a SUM list, **123–24**, 127

CTIME, **169**

Cube root, 41

in RPN, 265

Currency

clearing variables, **60**

converting, **59**

entering a rate, **57**

exchange, **57**, **58**

selecting, **55**

storing and recalling, **59**

Currency#1, **55**

Currency#2, **55**

Current equation, **156**

deleting, **162–64**

printing, **187**

CURRX menu, **55**, **255**

Cursor, **19**

movement keys, **32**

Curve fitting, 121, **132–34**

calculations, **134–37**

equations, **251**

Customer Support, **222**

## D

DELET

in CFLO menu, **92**

in Solver menu, 157, **164**

in SUM menu, **122**, 127

DB , **115**

DEL , **32**

DATE1 , **150**

DATE2 , **150**

DAYS , **150**

DATE

in appointment-setting menu,  
**145**

in SET menu, **143**

D.KR , **56**

DBL , 185

DEUT , **18**

DSP , **34–35**

Date

in the past or future, **151**

setting, **143–44**

viewing, **141**, **169**

Date arithmetic, **149–52**

Date format, 143, **144**

for appointments, **144**

DATE, Solver, **169**

Day of the week, determining,  
**149**

Day.month.year format, 143,

## 294 Index

## 144

- DDAYS, **169**
- Decimal places, **34**, 47
- Decimal point, **35**
- Declining balance depreciation.  
See Depreciation
- Deleting
  - all information, 225,  
**228–31**
  - characters, **32**
  - equations, **162–64**
  - from a CFLO list, 98, **100**
  - from a SUM list, **125**, 127
  - variables in the Solver,  
**162–64**
- Dependent variable, **134**
- DEPRC menu, **114**
- Depreciation
  - ACRS method, 114, **118–19**
  - calculations, **114–17**
  - declining balance method,  
114, **116–17**
  - equations, **250**
  - partial year, **118–19**
  - straight line, 114, **116**
  - sum of the years' digits, 114,  
**116**
- Diagnostic self-test, **232–33**
- Diagrams, cash flow, **64–66**,  
92–94
- Digit separator, **35**
- Direct solutions in Solver, 179,  
**240–41**
- Discount rate, **101**

- Display
  - clearing, **20**
  - contrast, **17**
  - format, **34**
  - in RPN, 268–73
  - messages, **36**
  - organization, **19**, 43
  - printing the contents of, **185**
  - turning on and off, **17**
- Displayed messages, **283**
- Displaying
  - the contents of registers,  
**43–46**
  - values assigned to variables,  
**28**
- Division, **38–40**
- Doublespace printing, **36**, 185
- DSP menu, **34–35**, 260

## E

- E** key, 47
- END** , **64**
- EXP** , **42**
- EDIT** , **157**, 161
- EURE** , **56**
- ENGL** , **18**
- ESP%** , **18**
- EFF%** key, **88**
- EXIT** , 25, **28**, 92, 96, 123, 147,  
161
- ENTER** , 263, **264–65**, **271**,  
274
- E, in numbers, **47**

## Editing

alphabetic information,

**31–32**

equations, **161**

keys, **31–32**

Effective interest rate, **84–87**,

100

End payment mode, **64**, 65

Ending value, in summation

function, **176**

English language, setting, **224**

## Entering

equations, **157–58**

guesses in the Solver,

**181–83**

Entering numbers

in a SUM list, **123–24**

in RPN, 264, 271

into CFLO lists, **95–97**

Environmental limits, **231**

Equals sign, used to complete

calculations, **21**, 38

Equation list. *See* Solver list

Equation Solver, **153–83**,

240–46

clearing, **163**

introduction, **29**

## Equations

algebraic rules, **164**

characters in, **166–67**

clearing, **163**

deleting, **162–64**

displaying, **162**

editing, **161**

entering, **157**

erasing, **163**

for built-in menus, **246–53**

invalid, **158**

length of, **153**

long, viewing, **166**

naming, **161**

verifying, **157–58**

writing, **164**

Erasing. *See also* Clearing;

Deleting

Erasing calculator memory, 225,

**230–31**

Error messages, 36, **283**

Estimates, entering in the Solver,

**181–83**

Examples, **190**

in RPN, 276–82

Exchanging registers, RPN, 269

EXP, **169**

EXPM, **169**

Exponential model, 130, 132,

**133**

Exponential numbers, **47**

Exponentiation, **41–42**, **265**

in equations, **165**

## F

FACT%, **115**

FRCST, **128**

FRAN, **18**

## 296 Index



**FV** key, **63**  
**FIX** key, **34**  
Face value, bond, **110**  
**FACT**, **169**  
Factorial, 42, **169**  
**FIN** menu, **256–57**  
**FLOW**, Solver, **169**  
Forecasting  
  calculations, **130–37**  
  equations, **251**  
  values, 121, **132–34**  
Foreign language, **224**  
Formatting number, **34**  
**FP**, **169**  
Fractional part, **169**  
**FRCST** menu, 130, **132**  
Functions in equations, 167,  
  **168–71**  
Future date, calculating, **151**  
Future value of a series of  
  payments  
  equation, **246**  
  Solver function, **171**

## G

**GO** , **82**  
**G.SD** , **132**  
**GET** , in CFLO, **99**  
**GET** , in SUM, **127**  
General business  
  calculations, **49–53**  
  equations, **247**

Grouped standard deviation,  
  **138–39**

Guesses  
  entering in the Solver,  
  **181–83**  
  *IRR%*, entering, **238–40**  
  Solver, **245**

## H

**HELP**

  in the appointment-setting  
  menu, **145**  
  in the SET menu, **143**

**HK\$** , **56**

Halting a numerical search,  
  **180**

Hierarchy of menus, **24**

Hierarchy of operations, in  
  equations, **165**

History stack, **43**. *See also*  
  Stack, RPN  
  printing, **186**

HMS, **170**

HP Solve. *See* Solver

HRS, **170**

Humidity requirements, **231**

## I

**INT** , **78**

**INSR**

  in CFLO list, 92, **98**  
  in SUM list, 122, **124**

**IRR%**, **101**  
**I%**, **101**  
**ITAL**, **18**  
**I%YR** key, **63**  
**IN.RS**, **INTI**, **56**  
, **98**  
 for storing equations, **30**  
 in CFLO menu, **92**  
 in RPN, 264  
 in the Solver list, **157–58**  
 in SUM list, **123**  
**I%**, **101**  
**ICNV**  
 equations, **248**  
 menu, **84–85**  
 variables, clearing, **86**  
**IDIV**, **170**  
**IF**, **170**, 174–76  
 nested, **175**  
 Independent variable, **134**  
 Individual Retirement Account,  
**72–73**  
 Inserting characters, **32**  
 Installing batteries, **225–26**  
 Insufficient memory, 37, **227**  
 Insurance policy, price,  
**213–15**  
**INT**, **170**  
**INT**, rounded in amortization  
 calculations, **78**  
 Interest  
 compound, **61**, 84  
 equation, **248**

on loan, amount of PMT  
 applied toward, **80–81**  
 simple, **61**  
 Interest rate conversions,  
**84–90**, 201, 248  
 effective and nominal, **84**  
 Intermediate results, RPN, 268,  
 274  
 Internal rate of return. *See also*  
**IRR%**  
 calculations, 91, 97,  
**100–101**  
 Interrupting an IRR% calculation,  
**239**  
 Interrupting the Solver, **180**  
**INV**, **170**  
 Invalid equation, **158**  
 Inverse, **265**  
 Investments  
 calculating IRR% and NPV of,  
**101–4**  
 with grouped cash flows,  
**104–5**  
**IP**, **170**  
**IRA**, 72–73, **206**  
**IRR%**, 100, 101, **209**  
**IRR%** calculations, **238–40**  
 halting, **239**  
**IRR%** estimate  
 making, **239–40**  
 seeing current, **239**  
**IRR%** solutions, types of,  
**238–39**

## 298 Index

ITEM, **170**  
Iteration in Solver, **179–83**,  
240, **242–46**

## L

**LIFE** , **115**  
**LIN** , **132**  
**LIST** , **186**  
**LOG** , **42**  
**LN** , **42**  
**LAST** , **44**  
in RPN, 273  
Language, setting, **224**  
Large number  
available, **47**  
in a list, **128**  
Large numbers, keying in and  
displaying, **47**  
Last result, copying, **44**  
LAST X register, RPN, 273  
Leasing, **74–77**, 199–200  
LEFT-RIGHT, interpreting,  
**242–46**  
Letter keys, **30**  
Linear estimation, 121,  
**132–34**  
Linear model, 130, **133**  
Linear regression, **121**  
List. See CFLO list; SUM list;  
Solver list  
List, RPN, 264  
rolling the stack, 269

**LN**, **170**  
**LNPI**, **170**  
Loan  
amortizing, **77–83**  
APR for, with fees, **193**  
**LOG**, **170**  
Logarithmic model, 130, 132,  
**133**  
Logarithms, **42**, 170  
Logical operators, 174  
Low memory, **227**  
Low power, **224**  
and printing, **184**  
annunciator, **184**

## M

**M** , **132**  
**MAT** , **109**  
**M%C** , **49, 53**  
**M%P** , **52, 128**  
**MEDN** , **128**  
**MIN** , **128**  
**MAX** , **128**  
**MODL** , **132**  
**MSG**  
in appointment setting menu,  
**145**  
in printer men, **186**  
**M/D** , **143**  
**M\$** , **56**

**MORE** key, **25**

 **MAIN**, **22–26**

 **MEM**, **37**

MAIN menu, **19**

Manual, organization of, **16**

Markup

on cost, 49, **52**

on price, 49, **52**

Math in equations, **165**, 167

MATH menu, 42, **260**

MAX, **170**

Mean, **251**

calculating, **128–30**

weighted, **138–39**

Median, **251**

calculating, **128–30**

Memory. *See also* Continuous

Memory

freeing, **227**

insufficient, **227**

losing, **225**, 230

using and reusing, **37**

Menu

labels, **19**

maps, 25, **254–60**

Menus

calculations with, **27–28**

changing, **25**, **28**

exiting, **28**

names of, **161**

printing values stored in,

**186–88**

sharing variables, **53**

Messages for appointments,

**146**

Messages, error, **283**


MIN, Solver, **170**


MOD, **170**

Mode of payments (Begin and  
End), **64**

Models, curve-fitting, **132**, 133

Modes

 **RPN**, 36, 261–62, **265**

 **PLG**, 36, 261, 262

 **MODES**, 185

beeper, 36

double-space printing, 36,  
185

menu map, 260

printer ac adapter, 36

Modified IRR, **209–12**, 253

Month/day/year format,  
**143–44**

Mortgage, 68, **69**. *See also*  
Loan

calculations, 67–71, **77–80**

discounted or premium, **191**

Moving average, **217–19**

MU%C, **50**

equation, **247**

MU%P, **50**

equation, **247**

Multiple equations, linking, **178**

Multiplication

## 300 Index

in arithmetic, 21, **38–40**  
in equations, **165**

## N

**NZ\$**, **56**

**NEXT**, **78**

**N**, **63**

**NAME**

in CFLO list, **98–99**

in SUM list, **126**

**NPV**, **101**

**NUS**, **101**

**NFV**, **101**

**NEW**, **157**

**NIS**, **56**

**N.KR**, **56**

**NT\$**, **56**

**NI**, **42**

**NOM%**, **85–86**

**N**, 63

N, non-integer, **63**, 72

Names

of equations, **161**

of lists, clearing, 99

of variables, **166**

Negative numbers

in arithmetic calculations, **22**

in cash-flow calculations,  
**92–94**

in TVM calculations, **64**

Neighbors in Solver, **243**

Nested IF function, in the Solver,

**175**

Net future value, 91, **101**

Net present value, 91, **101**

Net uniform series, 91, **101**

NFV

calculating, 91, **101**

equation, **249**

Noise Declaration, **237**

Nominal interest rate, **84–87**,  
100

Non-integer period, **172**

NOT, **174**

Notes, discounted, **216–17**

NPV

calculating, **100–101**

equation, 100, **248**

Number

lists. See CFLO list; SUM list;  
Solver list

of days between dates,  
**149–51**

of decimal points, **47**

of payments, in TVM, **62**  
range, **48**

Numbers. See also Value  
entering, RPN, 264, 271  
with exponents, **47**

Numerical solutions, **179–81**

NUS, **100**, 249

## O

**OLD**, **50**

**OFF**, **17**

Index 301

**ON**, **17**

Odd-period calculations,  
**172–73**, 195, 253

Operators, in equations,  
**164–67**  
in RPN, **266**, 268, 274

Option to buy, for a lease,  
**74–75**

**OR**, **174**

Order of calculation, in the  
Solver, **165**

**OTHER** menu, **146–47**

Overdue appointments. See  
Past-due appointment

Overview, **3**

## **P**

**PESO**, **56, 63**

**PRIN**, **78**

**PMT**, **63**

**P/YR**, **62**

**#P**, **78, 82, 85**

**PRICE**, 52, **109**

**PART**, **51**

**PWR**, **121**, 132

**PK.RS**, **56**

**PI**, **42**

**PORT**, **18**

**PRINTER**, **186**

**PRT**, **186**

Parentheses

in arithmetic calculations,  
**39–40**

in equations, **165, 167**  
in RPN, **266**, 268, 274

Partial period. See *also* Odd  
period  
payments, **62**

Past dates, calculating, **151**

Past due appointments  
acknowledging, **148**  
definition, **146**

Payment mode, **62**  
changing, **62**  
definition, **65–66**  
resetting, **62**

Payment periods, 62  
compounding, **61–64**  
in cash flow calculations, **93**  
vs. compounding periods,  
**87–90**, 200

Payments  
amortization, **77–81**  
lease, **74–77**  
number per year, in TVM, **63**  
TVM, **62**

Percent, **40**  
change, **49–51**  
key for simple interest, **40**,  
61  
of cost, 49, **52**  
of total, 49, **51**

Percentage calculations, **49–53**  
in RPN, 265

Periodic compounding,  
calculating interest rates for,

## **302 Index**

## **85–86**

Periodic interest rate, **101**  
Periodic rate of return, **100**  
Periods, **35**. See also Payment  
    periods in numbers  
    in numbers, **35**  
PI, **42**, 170  
PMT. See also Payments  
    in TVM, **63**  
    rounded amortization  
    calculations, **78**  
Positive numbers  
    in cash flow calculations,  
    **92–94**  
    in TVM, **64**  
Power. See also Low power;  
    Batteries  
    function, 41, 265  
    raising a number to, **41**  
Power curve, 130, 132, **133**  
Power on and of, **17**  
Precision of numbers, internal,  
    **34**  
Present value  
    definition, **63**  
    of a lease, **74–77**  
    of a series of payments, 171,  
    246  
    of a single payment, 171,  
    246  
Previous menu, displaying, **28**  
PRICE, as a shared variable, **53**  
Price, markup on, 49, **52**





Principal of loan, amount of  
    PMT applied toward,  
    **80–81**

Printer  
    power for, **185**  
    using, **184**  
PRINTER menu, **186**, 260  
Printer port, **184**  
Printing  
    amortization table, **81–83**  
    appointments, **188**  
    display, **185**  
    double space, **36**, 185  
    equations, **187**  
    history stack, **186**  
    interrupting, **189**  
    messages, **188**  
    number lists, **187**  
    slow, **184**  
    Solver list, **187**  
    speed, **185**  
    statistical values, **186**  
    time and date, **186**  
    variables, **187**  
    with tracings, **188**  
Prompting for #TIMES, **96**  
Purchase date, bond, **109**  
Purchase price, in mortgage  
    calculation, **68–69**  
PV, rounded in amortization  
    calculations, **78**

## **Q**

Questions, common, **222–24**

## R

- RANG** , **128**
- RPT** , **145**
- RATE** , **55**
- RMB** , **56**
- RP** , **56**
- RPN** , 36
- REGS** , **186**
- R** , **56**
-  **(RND)** , **35**
-  **(RI)** , 43, **263**
-  **(RCL)** , **45–46**, 98
  - in RPN calculations, 266
  - with variables, **28**
- R ↑** , **263**
- Radix (decimal point), **34**
- Range
  - calculating, **128**
  - of numbers, **48**
- Rate of return, periodic, **100**
- Recalling numbers, **45–46**
  - from variables, **28**
  - in RPN, 264, 266
  - with  **(LAST)** , **44**
- Reciprocal key, **41**
- Register storage, **45–46**
- Registers
  - arithmetic in, **46**
  - in RPN, 268–73
  - printing the contents of, **186**
- Relational operators, **174**
- Remaining depreciable value,

**115**, 116



- Renaming lists. See CFLO list; SUM list; the Solver list
- Repeating appointments
  - past-due, **148**
  - setting, **147**
- Replacing batteries, **225–26**
- Required rate of return, **101**
- Resetting the calculator, **228**
- Reusing
  - a number, RPN, 271, **273**
  - calculator memory, **37**, 230
- Reverse Polish Notation, 261
- RND**, **170**
- Rounding a *PMT*, **71**
- Rounding numbers, **35**
- RPN. See appendixes D, E, and F, or individual entries
- Running total, **123–24**

## S

- SL** , **115**
- SETT** , **109**
- SALV** , **115**
- SOYD** , **115**
- STDEV** , **128**
- SORT** , **128**
- SET** , **142**
- SELCT** , **55**
- SF** , **56**

## 304 Index



- S.KR , **56**
- S\$ , **56**
- STK , **186**
- SIZE , **132**
-  SHOW , **34**
-  STO , **45–46**
  - calculations with, RPN, 266
- S (function), **170**
- Sample standard deviation, **128**
- Saving numbers, **43**
- Savings account, 71–72
  - college, **202–6**
  - college, RPN, 278
  - regular, **200–202**
  - retirement, 208
  - retirement, RPN, 282
  - tax free, **206–9**
  - tax free, RPN, 280
- Savings calculations, **71–73**
- Scientific notation, **47**
- Self-test, **232–33**
- Service, **235–36**
- SET menu, **143**
- Setting a language, **18, 37**
- Setting an appointments, **146–47**
- Settings, default start-up, **230**
- Settlement date, **109**
- SGN, **170**
- Shared variables
  - in BUS, **53**
  - in equations, **162**
  - in ICNV, **86**
- Shift, **19**
- Sign of numbers
  - in cash-flow calculations, **92**
  - in TVM calculations, **64**
- Simple interest, **40**
  - with annual rate, **190**
  - with annual rate, RPN, 276
- Slope, in curve-fitting, **132**, 134
- Small numbers, keying in and displaying, **47**
- Smallest number
  - available, **47**
  - in a list, **128**
- SOLVE menu, **260**
- Solver, **153–83**. *See also* Equations
- Solver calculations, 155, **158–59**
  - creating custom menus, **153–54**
  - how it works, **179–83**
  - multiple solutions in, **179**
  - technical discussion of, **240–46**
  - using, **153–68**
- Solver estimates, seeing curren, **240–46**
- Solver functions, **168–71**
- Solver list
  - clearing, **162–64**
  - current equation, **156**

definition, **153**  
 deleting equations, 157,  
     **162–64**  
 deleting variables from,  
     **162–64**  
 editing an equation, **157**  
 empty, **156**  
 entering equations, **157–58**  
 printing, **187**  
 Solver menu, **156–57**  
     for multiple equations, **178**  
 Solver solutions, types of,  
     **243–46**  
 Solver variables. *See* Variables,  
     Solver  
 Sorting numbers, **128**  
 Spaces in equations, **166**  
 Specifying the number of  
     decimal places, **34**  
 SPFV, **171**, 246  
 SPPV, **171**, 246  
 SQ, **171**  
 SQRT, **171**  
 Square root  
     calculating, **41**, 265  
     Solver, **171**  
 Square, Solver, **171**  
 Squaring a number, **41**, 265  
 Stack. *See* History stack  
 Stack, RPN, 268–73  
     automatic movement of, 270,  
         274  
     clearing, 269, 273  
     dropping, 270  
     lifting, 270  
     losing contents off the top,  
         270  
     replicating contents in, 269,  
         270  
     rolling contents, 270, 271  
     size, 269  
 Standard deviation, **128–30**  
     calculating, **128–30**  
     grouped, **138–39**  
 Starting value, in summation  
     function, **176**  
 Statistical calculations, **127–40**  
 Statistical equations, **250–52**  
 Statistical variables, **128**,  
     130–34  
 Statistics,  $x$  and  $y$ , **130–34**  
 Step size, in summation function,  
     **176**  
 Storage registers, **45–46**  
     arithmetic in, RPN, **46**  
     printing the contents of, **186**  
 Storing numbers, 44, **45–46**  
     in built-in variables, **28**  
     in RPN, 264, 266  
 Subtraction, **21**, 38–40  
 SUM equations, **251**  
 SUM items, maximum number  
     of, **121**  
 SUM list  
     CALC menu, **128**  
     clearing, **127**  
     clearing numbers, **124**  
     copying a number from, **126**

## 306 Index

correcting, **124**  
 creating, **123–24**  
 definition, **121–22**  
 deleting numbers, **125**  
 editing, 122, **124–25**  
 entering numbers in, **123–24**  
 FRCST menu, **132**  
 GETting a new list, **127**  
 inserting numbers, **124**  
 largest number in, **128**  
 name, deleting, **127**  
 naming, **126**  
 printing, **187**  
 smallest number in, **128**  
 sorting, 121, **128**  
 starting a new list, **127**  
 viewing numbers, **124**  
 viewing the name of the  
 current list, **126**  
 SUM menu, **122–23**, 258  
 Sum of cash flows, **101**  
 Summation, 132, **139**, 171,  
 176–77  
     function, in the Solver,  
     **176–78**, 220  
     of lists, **177**  
     values, 132, **139**  
 Switching menus, **25–26**

**T**

#T, **171**  
 #TIMES, prompting, **96–97**  
 %TOTL, 49, **51**  
**TIME**  
     in appointment-setting menu,  
     **145**  
     in PRINTER menu, **186**  
     in SET menu, **143**  
**TABLE**, **78**  
**TOTAL**, 51  
     of a SUM list, 122, **128**  
**TYPE**, **109**  
**TODAY**, **150**  
**TRACE**, **186**  
**TOTAL**, sum of cash flows, **101**  
 Text, printing (MSG), **186**  
 Time  
     accuracy, **231**  
     and date, printing, **186**  
     changing, **143–44**  
     format, **144, 145–46**  
     of day, viewing, **141**  
     setting, **143–44**  
 TIME menus, **141–42**  
 Time value of money  
     calculations, **61–83**  
     equations, **247**  
 Top of the equation list, in the  
     Solver, **162**  
 Total, percent of, **51**  
 Trace-printing, **188**  
 TRN, **171**  
 Troubleshooting, 222–24  
 True population standard  
     deviation, **128**  
 Truncating function, in Solver,  
     **171**

Turning calculator on and off,  
**17**

## TVM

calculations, **61–83**  
equation, **247**  
instructions, **66–67**  
menu, **61–64**, 66  
variables, clearing, **64**

Typing aids, **167**

Typing alphabetic characters,  
**30**

## U

US\$, **56**

UK£, **56**

Unacknowledged appointments,  
**148**

Unit conversions, in the Solver,  
**178**

Unknown variables in Solver,  
**240**, 241

Up-arrow key, **43**

USFV, **171**, 246

USPV, **171**, 246

## V

### Values

clearing, **28–29**. *See also*

 CLR DATA

recalling, 28, **45–46**

storing, 28, **45–46**

transferring between menus,  
**28**

Variable,  
dependent, **134**  
independent, **134**

Variables  
statistical, **130–34**

Variables,  
built-in, **27**  
printing, **187**  
statistical, **128**

Variables, Solver, **154**  
clearing, **163**  
deleting, **163**  
names of, **166**  
shared, **162**

Variables, shared, **53**

Verifying equations, **157–58**

Viewing lists. *See* CFLO list;  
SUM list; Solver list

## W


W.MN, **132**


WON, **56**

Warranty, **233–35**

Weighted mean, 132, **138–39**

## X

, **41**

, 43

in RPN, 269

XOR, **174**

x-values, in forecasting,  
**133–34**

## 308 Index

## Y

YLD%, **109**

YR#, **115**

YEN, **56**

$y^x$ , 41, 265

Yield

of lease, **74–75**

to call, bonds, 108

to maturity, bond, **108**

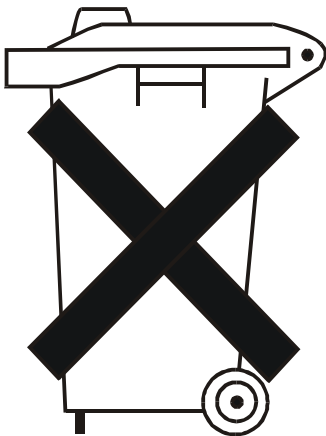
y-intercept, in curve-fitting, **132**,  
134

y-values, in forecasting,  
**133–34**

## Z

Zero-coupon bond, **113**

## **This regulation applies only to The Netherlands**



Batteries are delivered with this product, when empty do not throw them away but collect as small chemical waste.

Bij dit produkt zijn batterijen geleverd. Wanneer deze leeg zijn, moet u ze niet weggooien maar inleveren als KCA.